

perma Lubrication systems for

Blowers / Fans

perma-tec GmbH & Co. KG
Hammelburger Str. 21
97717 EUERDORF
GERMANY

info@perma-tec.com
www.perma-tec.com



The Expert in Lubrication Solutions

perma

perma Lubrication systems for **Blowers / Fans**

Blowers and fans are used in almost all industries. They provide adequate amounts of primary and secondary air. Flue gas fans remove air containing dust, gases and harmful substances. In primary air zones, induced draft fans are used in scrubbers, dust collectors, heat exchangers and desulfurisation plants.

- Chemical & pharmaceutical industry
- Glass industry
- Wood-working
- Power plants (power generation)
- Food industry
- Refineries
- Mining & heavy industry
- Pulp & paper industry

Lubrication points

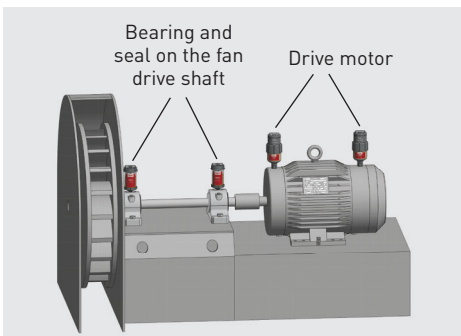

The lubrication points (roller bearings) are located at the **drive shaft** between drive motor and fan impeller.

Bearing and sealing of fan drive shaft is normally done by means of a pillow block housing or a bearing unit. These must be permanently supplied with the specified amount of the right lubricant.

Challenges



Blowers / fans are normally operated under **extreme conditions**. Contaminants such as dust or pumped media are raised and may infiltrate the bearing system. This causes increased wear in individual components and reduces service life.

- Contaminants (e.g. **dust**) raised in the air must not enter the lubrication points

Regular lubrication of bearings and seals is imperative. Lubrication points are often extremely dirty and hard to reach, which makes maintenance even more difficult. Specified lubrication intervals are neglected or not observed for this reason. The resulting **lubrication starvation** leads to increased wear and in extreme cases to failure of the blowers and fans.

- **Excessive overheating of bearing points** due to lubrication starvation
- Lubricants must be able to withstand **demands**, such as vibrations and high speeds
- **Compliance with relubrication intervals**, depending on bearing type, bearing size and ambient conditions

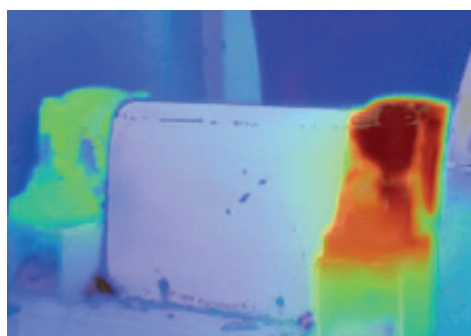

HINT

Manual for blowers / fans lubrication available on request.



Advantages of automatic lubrication

- ✔ perma lubrication systems seal lubrication points and **protect against contamination**
- ✔ **Precise metering** of lubricant amount reduces lubricant consumption
- ✔ Safe and reliable lubrication, also in areas with **potentially explosive atmospheres**
- ✔ Different lubricant volumes for **exact adjustment to lubrication point**

Reference



Solutions

Direct mounting on the lubrication point: e.g. with perma NOVA

- Easy, quick mounting
- For lubrication points with little vibration / shocks
- For easy-to-reach, safe lubrication points



perma NOVA 125

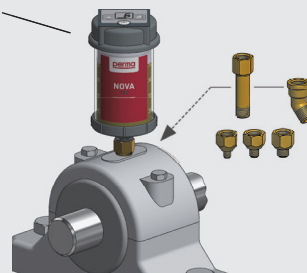

INSTALLATION KIT for perma NOVA

Use extensions, angles & reducers depending on the installation situation

Art. No. 101476

Remote mounting at lubrication point: e.g. with perma STAR VARIO

- For lubrication points with strong vibration / shocks (isolation of lubrication system)
- For lubrication points which are unsafe to access: Mounting in safe areas
- For hard-to-reach lubrication points



Beam clamp 30 mm

Art. No. 109957

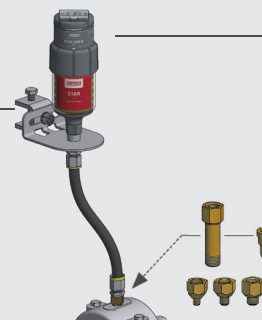

perma STAR VARIO with LC 120

INSTALLATION KIT STAR with 3.0 m tube

Use extensions, angles & reducers depending on the installation situation

Art. No. 101482

Applications

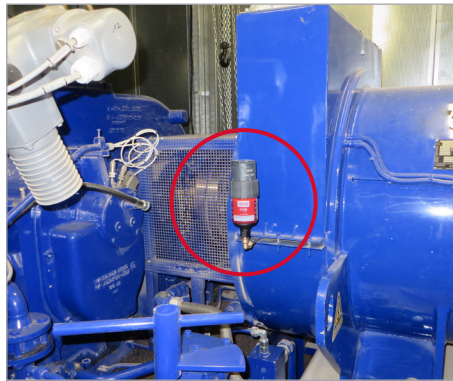
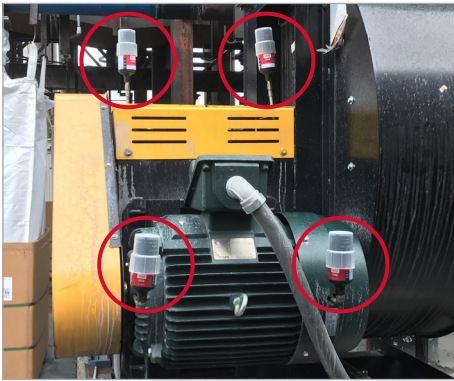
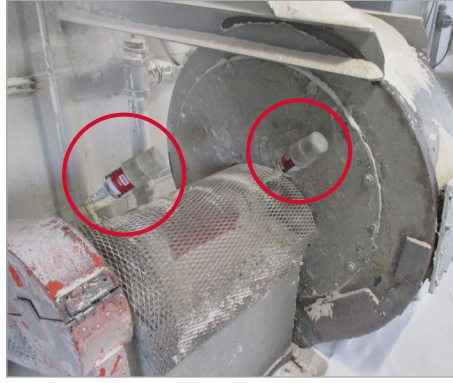

Individual solutions

perma Product portfolio



Solutions for all types of applications

perma Lubricants

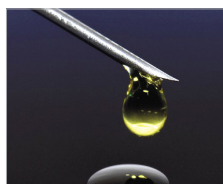

Large selection of high quality lubricants to meet the requirements of your equipment

perma Accessories



Extensive range of accessories and connecting parts for your equipment

perma SERVICE



Project planning, installation and maintenance

perma SOFTWARE



Calculation of lubricant amount: • **perma SELECT**
Maintenance Lubrication Program: • **perma MLP**