

Translation of the Original Operating Instructions

perma PRO 250 / 500

perma PRO C 250 / 500

perma PRO / PRO C LINE 250 / 500

perma Distributor PRO MP-6



The Expert in Lubrications Solutions

perma

This operating manual is valid for:

perma PRO 250 / 500	1 - 20
perma PRO C 250 / 500	21 - 40
perma PRO / PRO C LINE 250 / 500	41 - 44
perma Distributor PRO MP-6	45 - 61
Accessories and Spare Parts	62 - 63
Declaration of Conformity: <ul style="list-style-type: none">• perma PRO / PRO LINE• perma PRO C / PRO C LINE• perma Distributor PRO MP-6	64 - 66
Drilling template	67 - 68

© 2023 perma-tec GmbH & Co. KG

Without the specific approval of perma-tec GmbH & Co. KG no part of this documentation can be copied or made available to third parties.

We have taken great care when compiling all the details contained in this documentation. However, we cannot rule out discrepancies and we reserve the right to make technical changes to the product without giving advance notice.

We do not assume any judicial responsibility or liability for damages which may ensue as a result. We will include any necessary changes in the next edition.

Preface

About this Operating Manual
 Terms Used
 Usage of Safety Instructions
 Legal Requirements

Safety Instructions

Persons Responsible for Safety
 General Safety Instructions
 Safety Information for perma PRO / PRO C / PRO/PRO C LINE / Distributor PRO MP-6



The lubrication system perma PRO 1

Quick reference guide	3
1. General Information	4
1.1 Delivery / Content	
1.2 Storage	
1.3 Markings	
1.4 Intended Usage	
2. Technical Data	5
2.1 Design of the perma PRO Lubricator	
3. Mounting and Assembly of the Lubrication System	7
3.1 Mounting the Drive Unit onto a Fixing Device for Wall-Mounting	
3.2 Assembly of the Lubricator	
4. Display and Control Elements of the Lubrication System	10
4.1 Display Elements	
4.2 Function Indication on the Display	
4.3 Function Indication via the LEDs	
4.4 Control Buttons	
5. Operation and Control	11
5.1 Preparations	
5.2 Prior to Operation	
5.3 Setting into Operation	
5.4 During Operation	
5.5 Switching the Lubrication System On	
5.6 Switching the Lubrication System Off	
5.7 Determining the Discharge Period	
5.8 Settings and Display for perma PRO	
5.9 Calculation of the Remaining Discharge Period	
6. Replacement of the PRO LC	17
6.1 Setting the Volume of the PRO LC	
6.2 How to Replace the PRO LC	
7. Trouble Shooting	19
7.1 Error Messages on the Display	
7.2 Trouble Shooting Guide	
8. Disposal	20
9. Service	20

The Lubrication System perma PRO C 21

Quick Reference Guide	23
1. General Information	24
1.1 Delivery / Content	
1.2 Storage	
1.3 Markings	
1.4 Intended Usage	
2. Technical Data	25
2.1 Design of the perma PRO C Lubricator	
3. Mounting and Assembly of the Lubrication System	27
3.1 Mounting of the Drive Unit onto a Fixing Device for Wall-Mounting	
3.2 Assembly of the Lubricator	
3.3 Connect the Connecting Cable to the Lubricator	
4. Display and Control Elements of the Lubrication System	30
4.1 Display Elements	
4.2 Function Indication on the Display	
4.3 Function Indication via the LEDs	
4.4 Function Indication via the Connected Control System	
4.5 Control Buttons	



5. Operation and Control	31
5.1 Preparations	
5.2 Prior to Operation	
5.3 Setting into Operation	
5.4 During Operation	
5.5 Switching the Lubrication System On	
5.6 Switching the Lubrication System Off	
5.7 Determining the Discharge Period Without Impulse Mode	
5.8 Settings and Display for perma PRO C	
5.9 Calculation of the Remaining Discharge Period	
5.10 Impulse Mode via the Connected Control System	
6. Replacement of the PRO LC	37
6.1 Setting the Volume of the PRO LC	
6.2 How to Replace the PRO LC	
7. Trouble Shooting	39
7.1 Error Messages on the Display	
7.2 Fault Signaling via the Connected Control System	
7.3 Trouble Shooting Guide	
8. Disposal	40
9. Service	40

The Lubrication System perma PRO / PRO C LINE 250 / 500 41

The perma Distributor PRO MP-6 45

Quick Reference Guide	47
1. General Information	48
1.1 Delivery / Content	
1.2 Markings	
1.3 Intended Usage	
2. Technical Data	49
2.1 Design of the perma Distributor PRO MP-6	
2.2 Accessories	
3. Mounting and Assembly of the Distributor	51
3.1 Mounting the Connections	
3.2 Distributor Housing	
3.3 Combination of Distributor and Lubricator	
4. Operation and Control	54
4.1 Preparations	
4.2 Prior to Operation	
4.3 Setting into Operation	
4.4 During Operation	
4.5 Switching the Complete Lubrication System On	
4.6 Switching the Complete Lubrication System Off	
4.7 Determining the Discharge Period	
4.8 Setting the Discharge Period	
4.9 Activation of Outlets	
4.10 Initialization of Distributor	
4.11 Activation of Prefilling INIT FILL	
5. Trouble Shooting	60
5.1 Error Messages of the Distributor on the Display of the Lubricator	
5.2 Trouble Shooting Guide	
6. Disposal	61
7. Service	61

Accessories and Spare Parts 62

Declaration of Conformity 64

Drilling template 67

About this Operating Manual

- ◆ This operating manual is intended for the safe operation of the perma PRO/PRO C, PRO/PRO C LINE automatic lubricator and the perma PRO MP-6 distributor. It contains safety instructions which must be adhered to.
- ◆ Everyone who works on or with the lubricator and the distributor must have access to this operating manual during their shift. They must also pay attention to all relevant instructions and notices.
- ◆ The operating manual must always be kept complete and in easy to read condition.

Terms Used

- ◆ **Lubrication system perma PRO**
In the following text, the "lubrication system perma PRO" will either be called "lubricator" or by its name "perma PRO".
- ◆ **Lubrication system perma PRO C**
In the following text, the "lubrication system perma PRO C" will either be called "lubricator" or by its name "perma PRO C".
- ◆ **Lubrication system perma PRO/PRO C LINE**
In the following text, the "lubrication system perma PRO/PRO C LINE" will either be called "lubricator" or by its name "perma PRO/PRO C LINE".
- ◆ **Lubrication Canister**
In the following text, the "Lubrication Canister" will be called "PRO LC". The user can order the PRO LC with different lubricants and in size 250 cm³ and 500 cm³.
- ◆ **perma Distributor PRO MP-6**
In the following text, the "perma Distributor PRO MP-6" will either be called "distributor" or by its name "perma MP-6".
- ◆ **Battery PRO B**
In the following text, „battery PRO B“ will be called „battery“.

Usage of Safety Instructions

All safety instructions in this operating manual are standardized.



Danger Signs

This sign warns you of any danger to people's health or to subjects.



Tips

This sign alerts you to application tips which will help you in doing certain tasks quicker and safer.

Legal Requirements

Liability

- ◆ The information, data and tips stated in this operating manual were up-to-date as of the printing date. No claims for already delivered lubricators perma PRO/PRO C, PRO/PRO C LINE and distributors perma PRO MP-6 can be made based on the information, pictures and descriptions.
- ◆ perma-tec GmbH & Co. KG can not be held liable for damages and malfunctions caused by
 - inappropriate usage;
 - unauthorized alterations to the drive system, the PRO LC or the distributor;
 - inappropriate operations on or with the lubricator and the distributor;
 - incorrect operation and settings of the lubricator and the distributor;
 - incorrect settings of time and size of the complete lubrication system;
 - ignoring the operating manual of the distributor or the lubricator.

Warranty

- ◆ Warranty terms and conditions: see terms and conditions of sale and delivery appertaining to perma-tec GmbH & Co. KG.
- ◆ Lodge any warranty claims with your local supplier immediately after the defect or error has been identified.
- ◆ The warranty expires in all instances where no liability claims can be enforced.

Persons Responsible for Safety

- ◆ The operator or his safety officer must warrant,
 - that all the relevant regulations, instructions and laws are adhered to;
 - that only qualified personnel will work with and on the lubricator/distributor;
 - that unauthorized personnel are not allowed to work with and on the lubricator/distributor;
 - that the safety regulations are adhered to when mounting the lubricator/distributor or during maintenance.

General Safety Instructions

- ◆ We are not laying claim to completeness as regards these safety instructions. Please contact perma-tec Customer Service if you have any queries or problems.
- ◆ At the time of delivery the lubricator/distributor is in line with state-of-the-art technology and in principle is considered to be safe to operate.
- ◆ The distributor may only be used with a lubricator of the perma PRO range.
- ◆ Dangers emanate from the lubricator/distributor for persons, the lubricator/distributor itself and for other material assets of the operator if
 - unqualified personnel operates the lubricator/distributor;
 - the lubricator/distributor is used inappropriately and for operations that it was not intended to be used for;
 - the lubricator/distributor setting / variation is incorrect;
 - the lubricator/distributor is opened by force while in operation;
 - the lubricator/distributor is not mounted with the perma mounting device;
 - the tube connection to the lubrication point was not carried out and attached correctly.
- ◆ Operate the lubricator/distributor only when it is in perfect condition.
- ◆ Retrofitting, changing, or reconstructing the lubricator/distributor is not allowed. perma-tec must be consulted first.
- ◆ Only original tube connections and connectors from perma-tec can be used on or with the lubrication system since these will withstand high pressures of up to 25 bar (360psi).
- ◆ Only an original connecting cable from perma-tec can be used to connect the lubricator PRO C to your control system and your equipment.
- ◆ Ambient media, especially chemically aggressive substances, can attack seals and plastic.



Safety Information for perma PRO / PRO C / PRO/PRO C LINE / Distributor PRO MP-6

Safety during Installation and Maintenance

- ◆ Ensure that all workstations and traffic routes are clean and safe!
- ◆ Ensure that the relevant regulations and guidelines are adhered to when the installation or maintenance work is carried out in places where danger of falling exists.
- ◆ Ensure that the relevant safety and operating instructions are observed when the lubricators are installed or serviced on machines or in factories (e.g. to stop the machine).



Safety When Handling Lubricants

- ◆ Avoid contact of lubricant with eyes, skin, and clothing!
- ◆ Avoid swallowing of lubricant!
- ◆ Prevent lubricant from getting into soil or sewer system!
- ◆ Observe safety data sheets of lubricants!
You may also download data sheets of lubricants supplied by perma-tec from perma-tec's web page (www.perma-tec.com) or ask your local supplier.
- ◆ Lubricant on traffic ways will increase the danger of slipping! Therefore, immediately clean lubricant from floors with special cleaner.
- ◆ Only use original PRO LC from perma-tec!



Safety When Working on Electrical Equipment

- ◆ Works on electrical equipment may only be carried out by qualified personnel!
- ◆ Danger of sparking and fire hazard in case of a short-circuit!
- ◆ Do not work on live parts of the electrical equipment!
- ◆ Protect live parts of the electrical equipment according to the voltage, frequency and application type by insulation and by their position and arrangement!



Safety when Handling Batteries!

- ◆ Avoid contact of battery substances with eyes, skin and clothing!
- ◆ Avoid swallowing any leaking battery substances!
- ◆ Do not expose batteries to extreme heat and do not throw into open fire!
- ◆ Do not recharge batteries!
- ◆ Ensure that regulations for waste disposal of batteries are observed!
- ◆ Only use original batteries from perma-tec!

Translation of the Original Operating Instructions
perma PRO 250 / 500



The Expert in Lubrications Solutions



Lubrication System perma PRO

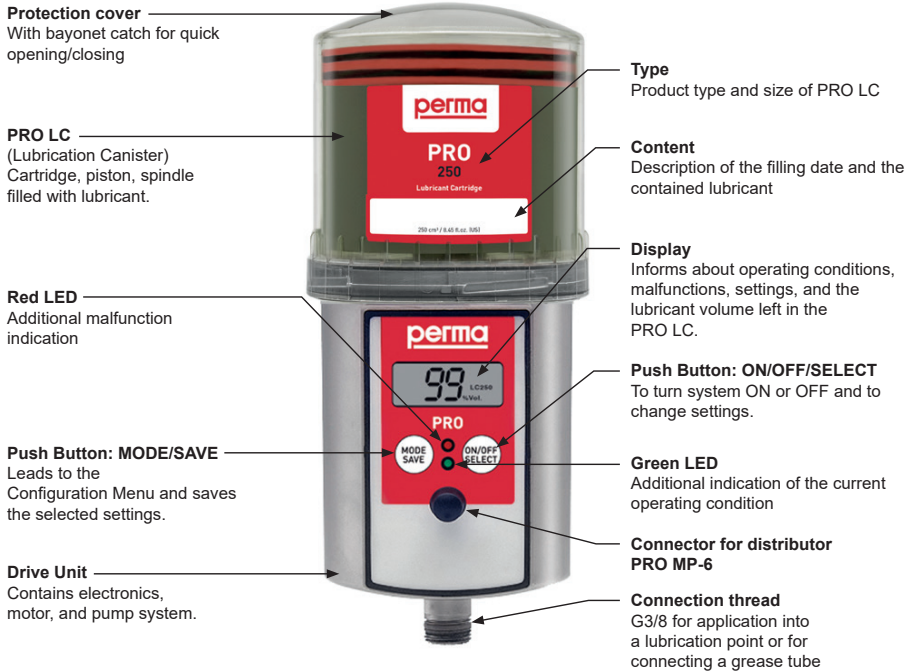

Display

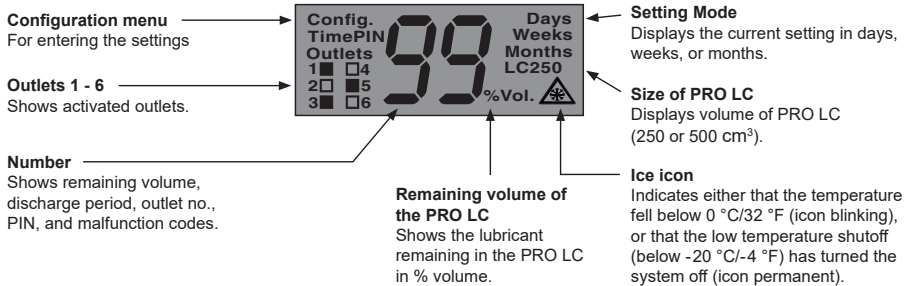

Drive Unit

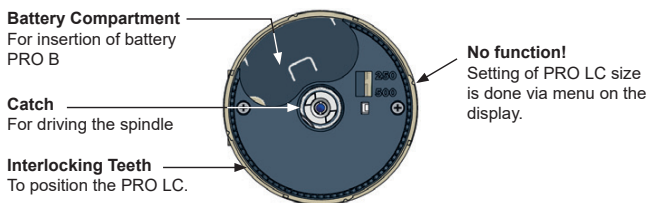

Battery PRO B

Quick Reference Guide for the Lubrication System perma PRO

On this page you will find some important information for quick and easy operation and setting of the perma PRO. Before the first installation of the perma PRO, and whenever you need detailed instructions, you should read the complete Operating Manual which contains information that must be observed. Make sure to follow the instructions given in the chapter "Safety Notes".

1 Assembly of perma PRO / Exchange of PRO LC (refer to chapter 3 and 6)

- ◆ Mount the drive unit on the mounting plate and secure it at the three pre-drilled holes (see attached template).
- ◆ Insert a new battery PRO B into the battery compartment (follow directions of the arrows).
- ◆ Place the PRO LC inside the cover and remove the plug of the PRO LC.
- ◆ Push the PRO LC into the cover until lubricant comes out of the opening.
- ◆ Place the PRO LC with its cover on the drive unit. Make sure that the catch locks and that the teeth of PRO LC and drive unit interlock.
- ◆ Turn the cover clockwise until the bayonet catch locks.

2 Determine Discharge Period (refer to chapter 5.7)

- ◆ Refer to the manufacturer's guidelines about the lubrication point that you want to lubricate, in order to determine the required lubricant amount in cm³ per one hundred operating hours.
- ◆ Refer to chart (chapter 5.7, chart 4) and find your required lubrication amount. Based on that, the chart will show you the required PRO LC size, the setting of the discharge period and the setting mode.

3 Setting of PRO LC Size, Discharge Period, Outlets and PIN (refer to chapter 5.8)

- ◆ Hold down the MODE/SAVE button until the set time is displayed.
- ◆ Hold down the MODE/SAVE button again until you reach the current PIN (PIN cannot be changed here/PIN setting at delivery is "00").
- ◆ Hold down the MODE/SAVE button again until you reach the other setting menus: PRO LC, discharge period, outlets (only with attached MP-6) and PIN change. Change settings with a short push of MODE/SAVE or ON/OFF/SELECT.

4 Save Settings (refer to chapter 5.8)

- ◆ Keep the MODE/SAVE button pressed until display shows "--".

5 Starting perma PRO (refer to chapter 5.5)

- ◆ Hold down the ON/OFF/SELECT button until the "Remaining Volume" appears in the display and the green LED starts blinking.

6 Stopping perma PRO (refer to chapter 5.6)

- ◆ Keep the ON/OFF/SELECT button pressed until the display shows "--".



1. General Information

1.1 Delivery / Content

- ◆ perma PRO will be delivered according to customer specifications in regards to type of grease and size of PRO LC.
The user must only assemble it and adjust the desired settings.
- ◆ Mounting device and screws included.
- ◆ Battery PRO B
- ◆ Operating instructions and EC Conformity Declaration included.
Upon delivery, make sure to check if the delivered goods correspond to your order. perma-tec GmbH & Co. KG will not accept liability for subsequent claims of any shortcomings.
- ◆ Please immediately forward any claims:
 - of noticeable transport damage directly to the forwarder.
 - of noticeable faults, shortcomings or defects directly to your perma distributor.

1.2 Storage

When the lubricators are not immediately installed, you must ensure appropriate storage conditions in dry, dust free places with a temperature of $+20\text{ °C} \pm 5\text{ °C}$ ($+68\text{ °F} \pm 9\text{ °F}$).

Make sure that PRO LC and battery PRO B are not stored longer than one year.

For drive unit (1) protection during storage: Do not remove protection cover (2), disc (3), and plug (4) until you are ready to install the system (see chapter 5.2).

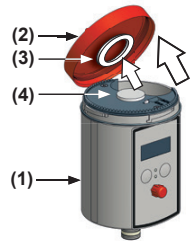

1.3 Markings

- ◆ The lubricator perma PRO is clearly marked with a label (serial number) on the drive system and a label on the PRO LC.
- ◆ **CE mark** on the drive unit
- ◆ **UL mark** on the drive unit:
"This equipment is suitable for use in Class I, Div. 2, Groups A, B, C and D; or Non-Hazardous Locations only.
Warning - Explosions Hazard - Substitution of components may impair suitability for Class I, Division 2.
The lubricants dispensed by this equipment are to have flash points greater than 200 °F."
- ◆ **EAC mark** on packaging
- ◆ Manufacturer:
perma-tec GmbH & Co. KG
Hammelburger Straße 21
97717 Euerdorf
Germany
Tel: +49 (0) 9704 609-0 E-mail: info@perma-tec.com
Fax: +49 (0) 9704 609-50 Web page: www.perma-tec.com

1.4 Intended Usage

The lubricator perma PRO

- ◆ immediately supplies all lubrication points with lubricant, at a **pressure build-up of max. 25 bar** (360 psi.), permanently, precisely and independent of temperature;
- ◆ has passed the environmental audit according to standard EN 60068-2-6 (vibration test) without any component damage or malfunctions. In test: PRO drive unit with MP-6, PRO LC 500 cm³, and mounting device in various mounting positions;
- ◆ can be used for all lubrication points of sliding- and roller bearings, drive- and transport chains, sliding guideways, open gears and seals;
- ◆ **must** be used with a suitable protection box (refer to "Accessories and Spare Parts") if operated outside or around splashing water;
- ◆ should only be connected to/used with original lubrication tubes from perma-tec GmbH & Co. KG;
- ◆ is intended for use on machinery and equipment;
- ◆ is only to be used for the ordered purpose and purposes confirmed by perma-tec;
- ◆ is only to be used for operating conditions recommended in this operating manual;
- ◆ is only to be used with settings and variations recommended in this operating manual.

Any other usage, setting, addition, and variation is considered to be inappropriate!



2. Technical Data

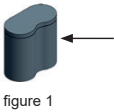

	PRO 250	PRO 500
Volume of the PRO LC	250 cm ³	500 cm ³
Length (L)	210 mm	260 mm
Diameter (D)	92 mm	92 mm
Weight, empty	1.30 kg	1.37 kg
Weight, filled with perma High performance grease SF04	1.53 kg	1.82 kg
Discharge period	1 day to 24 months	1 day to 12 months
Discharged volume per lubrication impulse	0.5 cm ³	
Application temperature	-20 °C to +60 °C / -4 °F to +140 °F	
Maximum pressure build-up	25 bar / 360 psi	Combination of these Maximum-Values can only be realized by temperatures of ≥ 20 °C/ 68 °F. At lower temperatures, the application is limited according to the diagram below.
Maximum tube length (inner-Ø 5 mm)	5 m	
Lubricants	Greases up to rated consistency NLGI 2	
Power supply	Battery PRO B (3 V alkaline manganese, not rechargeable)	
Emission sound pressure level	< 70 dB(A)	
Connection thread	G3/8	
Protection class	IP 54	

chart 1

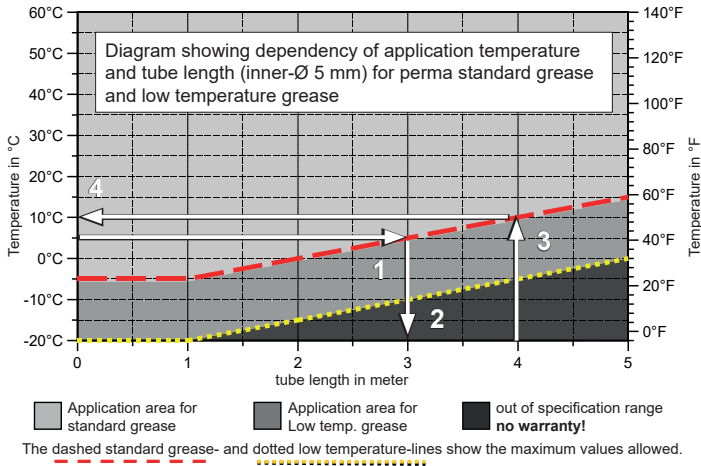

If your application is out of the specification range shown in this diagram, please contact your local distributor. perma-tec cannot be held liable for these applications.

Example:

1. The application temperature is +5 °C / +41 °F. What is the maximum tube length allowed for standard grease?
Correct Answer: 3 m max. tube length for standard grease, 5 m max. tube length for low temp. grease (arrow 1 meets the dashed line of the standard grease range at 3 m).
2. You want to use a 4 m tube. Up to which temperature can the system be used?
Correct Answer: +10 °C / 50 °F with standard grease -5 °C / 23 °F with low temp. grease (arrow 3 meets the dotted line of low temp. grease at the -5 °C mark; and the dashed line of the standard grease at the +10 °C mark).

2.1 Design of the perma PRO Lubricator

Lubricators are available as 250 cm³ and 500 cm³ versions and they can be supplied with the lubricant requested by the customer. They consist of (refer to figure 2):

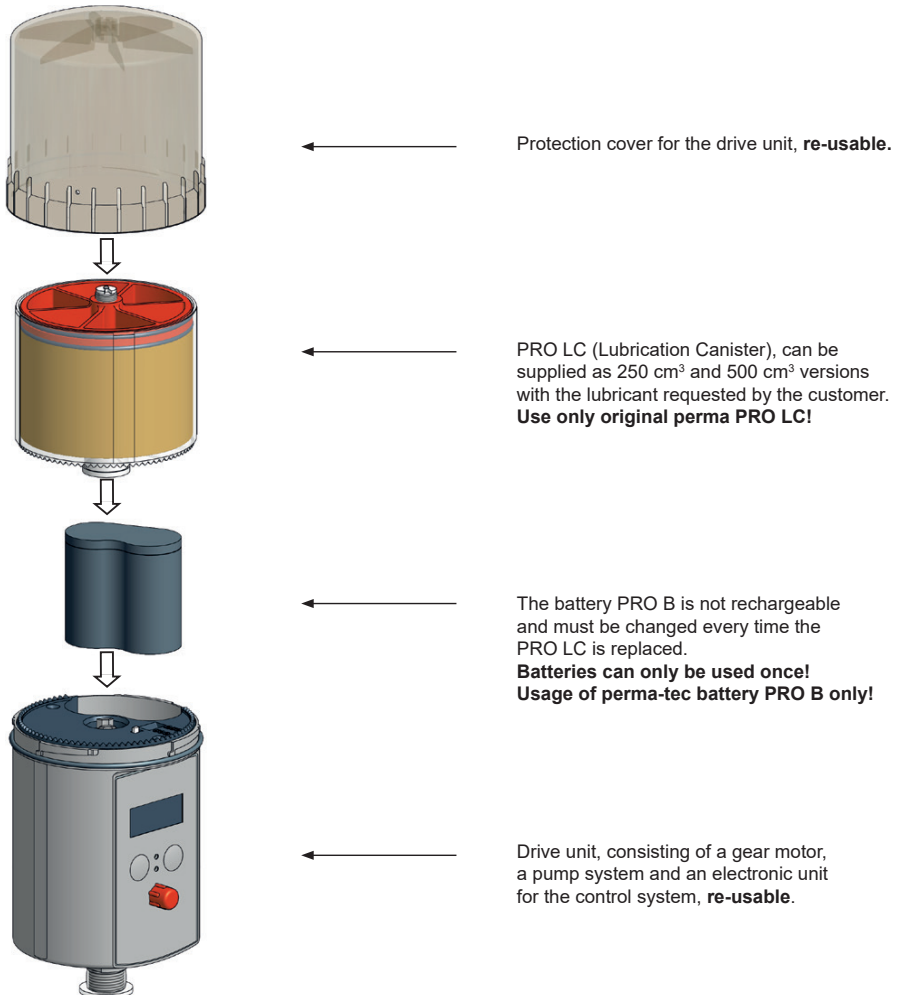



figure 2

3. Mounting and Assembly of the Lubrication System

3.1 Mounting the Drive Unit onto a Fixing Device for Wall-Mounting

- ◆ Attach the supplied mounting device to the drive unit using the two enclosed hex head bolts (M6 x 16) and the two washers.
- ◆ Screw the mounting device with the drive unit onto a support of your system.
The boring template of the three mounting screws (141.5 x 45) can be seen below in figure 3 or on the template that is included. You have to use at least three hexagon screws M6 x 25 (e.g. on metal ground).
- ◆ Before you connect the outlet of the drive unit to the lubricant tube, you have to make sure that the lubrication points and the complete lubricant tube is pre-lubricated with the same lubricant that is contained in the PRO LC. For that, perma-tec offers a 400 g lubrication cartridge for manually-operated grease presses with the requested lubricant.
- ◆ Connect the lubricant tube (connection G3/8) to the outlet of the drive unit and install the tube correctly between the outlet and the lubrication point. The lubricant tube must not be longer than five meters.

 **Make sure that you assemble the connections and lubricant tubes correctly and tightly to avoid possible leakage.**

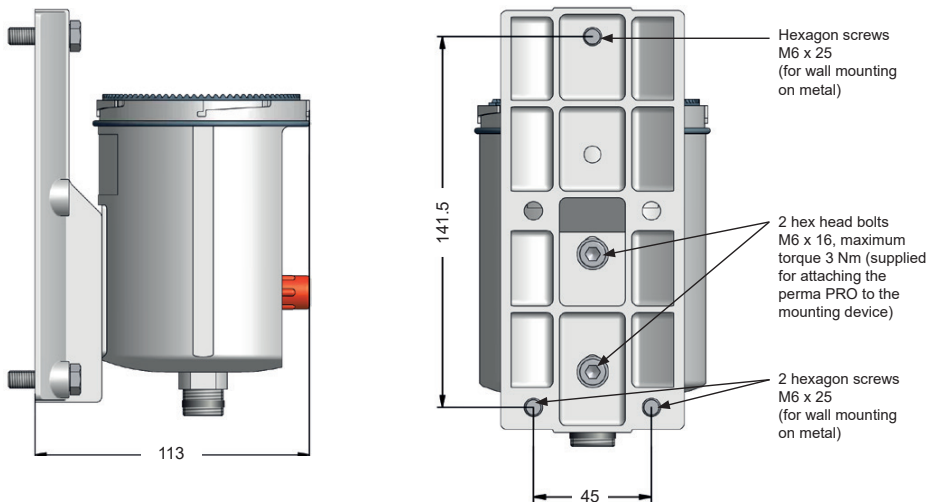

figure 3

3.2 Assembly of the Lubricator

a)

- ◆ Insert the battery PRO B into the drive unit (according to the direction of the arrow on the label).

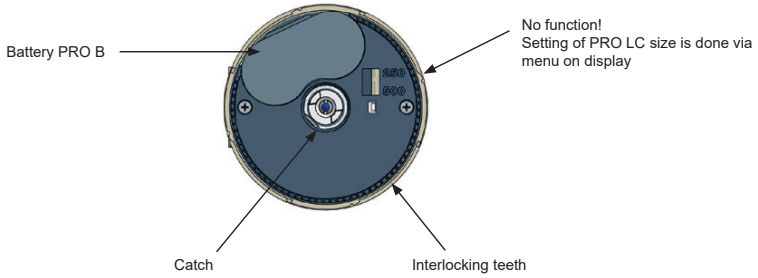

figure 4

b)

- ◆ Place the PRO LC inside the protection cover and remove the plug of the PRO LC (refer to figure 5).

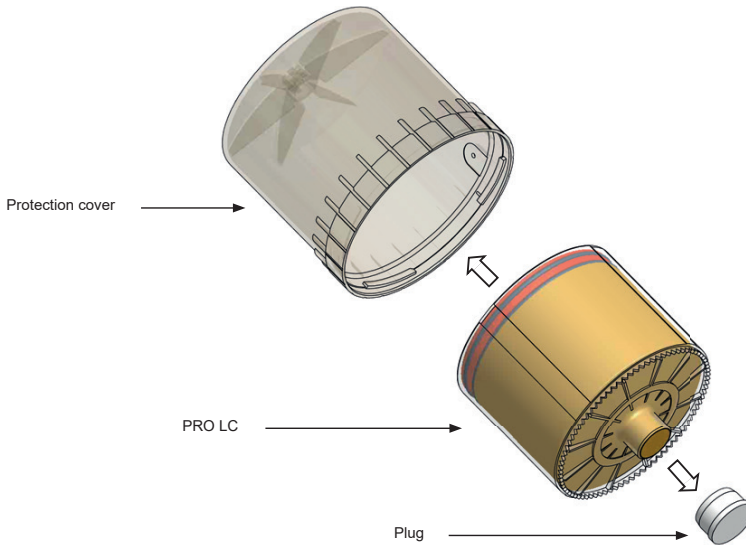

figure 5

c)

- ◆ Push the PRO LC into the protection cover until lubricant comes out of the opening (refer to figure 6).

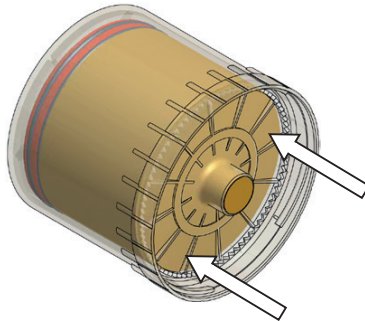

figure 6

d)

- ◆ Place the PRO LC with its protection cover on the drive unit. Make sure that the catch locks and that the teeth of the PRO LC and the drive unit interlock (refer to figure 4 and figure 7).
- ◆ Turn the cover clockwise until the bayonet catch locks.

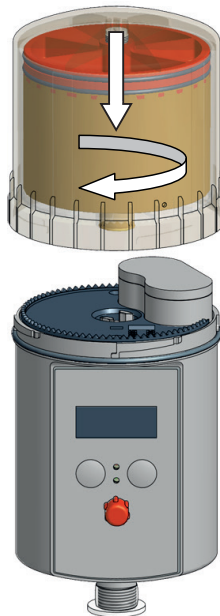

figure 7

4. Display and Control Elements of the Lubrication System

4.1 Display Elements

The operating status of the lubricator can be determined via the green or the red LED and via the display at the control unit (refer to figure 8) of the perma PRO.

The perma PRO offers a menu-guided setting. Changes of the settings are shown on the display. Error messages, e.g. in case the pressure in the lubricant tube gets too high, are also indicated on the display.



figure 8

4.2 Function Indication on the Display

The display is located on the control unit of the perma PRO (refer to figure 8, chapter 4.1). The display shows settings, operating conditions and error messages of the lubricator.

In case of an error free operation of the lubrication system, the display shows the remaining volume of the mounted PRO LC in percent volume (% Vol.). Figure 9 shows an example of the displayed information if the PRO LC 500 is new and full.



figure 9

The display cannot be switched off by the operator. If the lubrication system is switched off, the display will always show two lines (see figure 10 below).



figure 10

4.3 Function Indication via the LEDs

LED	Signal	Signal Length	Explanation
green	flash	every 10 seconds	operation (OK)
red	flash	every 3 seconds	error / malfunction
green and red	flash	every 3 seconds	PRO LC empty
green	light	permanently	Lubricator is discharging
green and red	none	none	Lubricator switched off or battery low

chart 2

4.4 Control Buttons

There are two push-buttons on the control unit (refer to figure 8) which can be used for a menu-guided change of the settings.

- ◆ With the MODE/SAVE button (refer to figure 11), you can reach the configuration menu, change the mode and save the modified settings for further operation.
- ◆ With the ON/OFF SELECT button (refer to figure 12) you can do the following: turn lubricator On/Off, increase discharge period (Days, Weeks, Months - each time you press the button increases the discharge period by one calendar unit), change PRO LC size, activate MP-6 outlets and set PIN.





PRESS	Short	Short	Long > 4 sec. until the display content changes completely	Long > 4 sec. until the display content changes completely
BUTTON	 figure 11	 figure 12	 figure 11	 figure 12
FUNCTION	Selection in current display	Changing of values	Moves to new menu and saves selected values	Returns to original menu without saving changes

chart 3, figure 11, figure 12

5. Operation and Control

5.1 Preparations

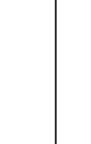
- ◆ Prior to the installation of the lubricator, the lubrication point and the complete connection tube must be sufficiently prelubricated with the same lubricant that the PRO LC contains. For this, perma-tec offers a 400 g lubrication cartridge for grease presses with the corresponding lubricant (refer to "Accessories and Spare Parts").
- ◆ When installing the perma PRO, the supplied perma-tec mounting device should be used.
- ◆ The lubricant tube must be installed and mounted correctly. The length of the lubricant tube may not exceed a maximum of 5 meters and the tube must be a perma-tec product.
- ◆ Please check if the thread of the perma PRO (G3/8) corresponds to the connection thread of the lubrication point. If this is not the case, you can order a corresponding reducer or other parts from the perma accessory range.

 **During initial operation, the perma PRO drive is filled with perma Food grade grease H1 SF10. Please press "additional discharge" repeatedly in order to exchange the lubricant in the drive until the lubricant inside the LC is discharged at the drive outlet (refer to chapter 5.8).**

5.2 Prior to Operation

- ◆ Check all parts of the lubricator for obvious damages!
- ◆ Is the new PRO LC filled with the required lubricant?
- ◆ Did you insert a new battery PRO B?
- ◆ Did you remove protection cover, disc and plug from drive unit (see chapter 1.2)?
- ◆ Did you assemble and mount all of the parts correctly and tightly?

5.3 Setting into Operation

- ◆ If necessary, mount the drive unit onto a fixing device for wall-mounting (refer to chapter 3.1).
- ◆ Insert the battery PRO B into the drive unit and the PRO LC into the protection cover and close the complete system (refer to chapter 3.2).
- ◆ Determine the discharge period (refer to chapter 5.7).
- ◆ Set volume of PRO LC discharge period, outlets of MP-6, and the PIN via buttons on display (refer to chapter 5.8).
- ◆ Switch-on the lubrication system (refer to chapter 5.5).
- ◆ Carry out an additional discharge (refer to chapter 5.8).
If the drive motor has started and the green LED is lit, the lubricator has started to discharge. The display indicates the remaining volume (% Vol.) of the PRO LC.



The operator must always check the customer-specific settings and if necessary change them before the lubricator is set into operation!

5.4 During Operation

- ◆ Carry out regular inspections during the operation. You should pay special attention with regard to leakage and to the condition of the lubricator!
- ◆ Check the condition of the lubricant tube and the connections regularly!
- ◆ Check the filling level of the transparent PRO LC regularly!
- ◆ After one or several additional discharges, you have to calculate the reduced discharge period and note this on your lubrication and maintenance schedule.
- ◆ If a malfunction is indicated on the display, you can determine the cause using the trouble shooting guide (refer to chart 7, chapter 7.2). If the fault cannot be fixed, please contact your supplier for technical support.



Additional discharges and long machine standstills must always be taken into account with regard to the remaining discharge period of the lubricator.

5.5 Switching the Lubrication System On

To switch the lubrication system on (refer to figure 13), keep the ON/OFF/SELECT button pressed until the indication ("--") on the display is replaced by an indication of the remaining volume – e.g. 99 % VOL (with a new PRO LC) – and the green LED starts blinking.



figure 13

5.6 Switching the Lubrication System Off

To switch the lubrication system off (refer to figure 14), keep the ON/OFF/SELECT button pressed until the display no longer indicates the remaining volume – % VOL – but indicates ("--") instead. When the lubrication system is switched off, all of the settings are saved. This means that if you start the lubricator again, it will take up the operation at the point where it had been switched off.



figure 14

5.7 Determining the Discharge Period



The discharge period is automatically factory-set to six months according to the supplied PRO LC. Upon request, a factory-setting of the discharge period required by the customer is also possible. The size of the PRO LC is taken into account.

If you want to determine the discharge period, you need to know the required amount of the lubricant in cubic centimeters for 100 operating hours (cm³/100 h). This information can be taken from the technical documents of the manufacturer of the lubrication point.

With this information, you can determine the discharge period using the following chart (chart 4).

		Average discharge volume in cm ³ per 100 operating hours					
PRO LC		250			500		
Setting point Discharge period	Setting mode	Days	Weeks	Months	Days	Weeks	Months
	1		1041.7	148.8	34.3	2083.3	297.6
2		520.8	74.4	17.1	1041.7	148.8	34.3
3		347.2	49.6	11.4	694.4	99.2	22.8
4		260.4	37.2	8.6	520.8	74.4	17.1
5		208.3	29.8	6.9	416.7	59.5	13.7
6		173.6	24.8	5.7	347.2	49.6	11.4
7		148.8	21.3	4.9	297.6	42.5	9.8
8		130.2	18.6	4.3	260.4	37.2	8.6
9		115.7	16.5	3.8	231.5	33.1	7.6
10		104.2	14.9	3.4	208.3	29.8	6.9
11		94.7	13.5	3.1	189.4	27.1	6.2
12		86.8	12.4	2.9	173.6	24.8	5.7
13		80.1	11.4	2.6	160.3	22.9	--
14		74.4	10.6	2.4	148.8	21.3	--
15		69.4	9.9	2.3	138.9	19.8	--
16		65.1	9.3	2.1	130.2	18.6	--
17		61.3	8.8	2.0	122.5	17.5	--
18		57.9	8.3	1.9	115.7	16.5	--
19		54.8	7.8	1.8	109.6	15.7	--
20		52.1	7.4	1.7	104.2	14.9	--
21		49.6	7.1	1.6	99.2	14.2	--
22		47.3	6.8	1.6	94.7	13.5	--
23		45.3	6.5	1.5	90.6	12.9	--
24		43.4	6.2	1.4	86.8	12.4	--
25		41.7	--	--	83.3	--	--
26		40.1	--	--	80.1	--	--
27		38.6	--	--	77.2	--	--
28		37.2	--	--	74.4	--	--
29		35.9	--	--	71.8	--	--
30		34.7	--	--	69.4	--	--

chart 4



Please take into account that in case of one or several additional discharges, the remaining discharge period of the lubrication system must be recalculated (refer to chapter 5.9). This also applies in case of a cut-off of the lubrication system due to a long machine standstill (e.g. weekends or annual holidays). You should also note the result of your calculation of the remaining discharge period in your lubrication and maintenance schedule.

5.8 Settings and Display for perma PRO (+ Distributor PRO MP-6)
(see caption on page 15)

MODE SAVE	Display	CN/OFF SELECT	Meaning / Description	
	--		Display at delivery with attached PRO LC	
↓ MODE SAVE	Time 06 Months		Shows discharge period PIN-reset	Info
↓ MODE SAVE	PIN 00	Change first digit ↓ CN/OFF SELECT	Enter first digit of current PIN PIN "00" at delivery	PIN Entry
↓ MODE SAVE	PIN 00	Change second digit ↓ CN/OFF SELECT	Enter second digit of current PIN	
↓ MODE SAVE	Config. LC LC 500	Change from LC500 to LC250 ↓ CN/OFF SELECT	Set PRO LC size	LC
↓ MODE SAVE	Config. Time 06 Months	Change Months ↓ CN/OFF SELECT	Set discharge period: Months <u>or</u> Weeks <u>or</u> Days	Time
↓ MODE SAVE	Config. Time 01 Weeks	Change Days or Weeks ↓ CN/OFF SELECT	Set discharge period: Go to "Days" or "Weeks"	
↓ MODE SAVE	Config. 1 Outlets 1 <input type="checkbox"/> 4 2 <input type="checkbox"/> 5 3 <input type="checkbox"/> 6	Outlet 1 On / Off ↓ CN/OFF SELECT	Activate outlets: Activate outlet 1 Outlets only displayed if MP-6 is connected	Outlets
	Config. 1 Outlets 1 <input checked="" type="checkbox"/> 4 2 <input type="checkbox"/> 5 3 <input type="checkbox"/> 6		Outlet 1 activated	
↓ MODE SAVE	Config. 2 Outlets 1 <input type="checkbox"/> 4 2 <input checked="" type="checkbox"/> 5 3 <input type="checkbox"/> 6	Outlet 2 On / Off ↓ CN/OFF SELECT	Outlet 2 activated (if desired, other outlets may be turned On / Off the same way)	
↓ MODE SAVE ↓ MODE SAVE	Config. PIN 00	Change first digit ↓ CN/OFF SELECT	PIN (first digit) enter for initial configuration or after a PIN-reset – otherwise, setting is complete	PIN
↓ MODE SAVE	Config. PIN 00	Change second digit ↓ CN/OFF SELECT	PIN (second digit) enter for initial configuration or after a PIN-reset	
↓ MODE SAVE	--		Configuration finished	

I N T R O
C O N F I G U R A T I O N M E N U

chart 5

Caption for Chart on Left Side

Instructions should be followed from top to bottom and from left to right (also refer to chart 3). The instructions correspond to the operating sequence on the turned-off lubrication system perma PRO. Configuration is also possible if perma PRO is On.

Function	short push	long push	blinking display	go to
Symbol	↓	↓	⋮	→

chart 6

CONFIGURATION SECTIONS (see vertical bar, chart 5)

I N T R O

INTRO informs **Info** and asks for the current PIN. **PIN Entry**

C O N F I G U R A T I O N M E N U

Settings can be changed in the configuration menu with its different sections (LC, Time, Outlets, PIN).

LC

You can change the PRO LC size from LC250 to LC500 and back by pushing the ON/OFF/SELECT button (refer to chapter 6.1 and 6.2).

Time

The discharge period can only be set in **one** type of calendar unit (i.e. either Months, Weeks or Days). When the highest unit size is reached, counting starts again with number "00".

Outlets

If a MP-6 distributor is connected, outlets 1 - 6 can be set individually. The activated outlets 1 - 6 are displayed with a filled-in square in the display (please refer to the operating instruction of the MP-6 distributor for more details).

PIN

We strongly suggest to enter a personal PIN in order to protect your settings from unauthorized access. The PIN can **only be changed during initial configuration or after a PIN-reset**. A PIN-reset (short push of buttons: left-left-right-right-left in the INTRO-Info-menu) changes your personal PIN back to "00". The PIN-reset was successful when the displayed time disappears for a second and then comes back on. All other settings remain unchanged.

Save or Reject Changed Settings

The display settings can be saved with a long push of the MODE/SAVE button. If you do **not** want to save your changes to settings that are currently displayed in the configuration menu (LC, Time, Outlets, PIN), press the ON/OFF/SELECT button until the display shows either ("--") for Off or the remaining volume of the PRO LC in % VOL. All other settings and already saved changes remain valid.

Automatic Termination of the Configuration Mode

If you do not press a button in the configuration menu for 180 seconds, the control system is automatically switching back to the previously set mode ("On" or "Off") without saving the changes. All other settings and already saved changes remain valid.

Additional Discharge

With an additional discharge, a lubrication point can be supplied with an additional amount of the lubricant. For an additional discharge, the lubrication system must be switched on (display shows remaining volume) and you have to press both buttons simultaneously and hold them down (refer to figure 15).



figure 15

Lubricator On



For an additional discharge, press both buttons at the same time and hold them down (> 4 sec.)

An additional discharge is only possible at temperatures above 0 °C / 32 °F (figure 16, ice crystal is not visible) and when the lubrication system is not currently conducting a regular discharge.

Every additional discharge reduces the remaining discharge period since an increased amount of the lubricant has been supplied. This must be taken into account in your lubrication and maintenance schedule. A calculation is possible with the formula from chapter 5.9 and with the remaining volume which is displayed.

The time between two additional discharges is 30 seconds. Each additional long push of both buttons (simultaneously, figure 15) during this time is being registered and will lead to even more additional discharges. The system remembers a max. of 5 additional discharges.



Low-Temperature Cut-Off of the Lubrication System

The temperature range from 0 °C to -19 °C (32 °F to -2.2 °F) is indicated by a blinking ice crystal symbol (refer to figure 16).

In this temperature range the lubrication system perma PRO continues to operate without interruption.

Please note, that in this temperature range an additional discharge is not possible!



figure 16

Display with a blinking ice crystal (in this example with 89 % Vol.)

In order to protect the system from damage, the low-temperature cut-off of the lubrication system is automatically carried out by the control system and the built-in temperature sensor.

If the temperature reaches or falls below -20 °C (-4 °F), the lubricator is switched off by the low-temperature cut-off and the ice crystal symbol is permanently indicated on the display. The remaining volume is still displayed in % Vol.



From this time onwards, the lubricant is no longer discharged. You have to take this fact into account if your system continues to operate in order to prevent damages!

As soon as the temperature rises and reaches -19 °C (-2.2 °F) or higher, the control system switches the lubrication system on. The display shows the remaining volume and the blinking ice icon.



All discharges (except additional discharges), accumulated during the shut-off, will be caught up when the system continues operation (at a max. of two additional discharges with every regular discharge).

5.9 Calculation of the Remaining Discharge Period



Please note, that in case of one or several additional discharges, the remaining discharge period of the lubrication system must be recalculated. This also applies in case of a cut-off of the lubrication system due to a long machine standstill (e.g. weekends or annual holidays) or in case of a low-temperature cut-off carried out by the system if temperatures reach -20 °C (-4 °F).

You should also note the result of your calculation of the remaining discharge period in your lubrication and maintenance schedule.

$$\text{Formula: } R_{DP} = \frac{SDP * RV}{100}$$

SDP: Set Discharge Period of the lubricator (days, weeks, months)

RV: Remaining Volume (displayed in % Vol.)

R_{DP} : Remaining discharge period (days, weeks, months depending on SDP)

Example of a Calculation of the Remaining Discharge Period

The perma PRO with a 250 cm³ PRO LC was originally set to a discharge period (SDP) of eight months, since the lubrication point needs 4.3 cm³ lubricant /100 h. After two months, the perma PRO indicates a remaining volume (RV) of 75 % Vol. At this point, the lubricator is switched off for six weeks (e.g. machine standstill). When it is switched on again, you would like to determine when the PRO LC will be empty.

$$R_{DP} = \frac{SDP * RV}{100} = \frac{8 * 75}{100} = \frac{600}{100} = 6$$

This results in a remaining discharge period of six months. After these six months, the PRO LC will be empty and must be replaced by a new one.

6. Replacement of the PRO LC

The Following Must Always Be Taken into Account

If the replacement of an empty PRO LC becomes necessary, it will be indicated by a simultaneous blinking of the red and the green LED. Additionally, the display indicates that the PRO LC is empty (refer to figure 17).



figure 17

If you replace the PRO LC, you also have to change the battery PRO B. Otherwise, the correct operation of the lubricator cannot be guaranteed!

If you replace the PRO LC by a PRO LC of a different size, a corresponding protection cover (refer to "Accessories and Spare Parts") must be used.

Since the drive unit and the control board must be protected against moisture, an exchange may only be carried out in dry conditions!

After the installation of the new PRO LC, the control system continues to operate using the previously valid setting of the discharge period.

6.1 Setting the Volume of the PRO LC

The size of the PRO LC must be set in the configuration menu with the two buttons on the drive unit (see figure 18). Please also refer to the operating chart (chart 5, chapter 5.8).

ATTENTION!
If the displayed setting does not correspond with the attached PRO LC size it will result in incorrect discharge amounts and wrong signals in the display (Display, LEDs).

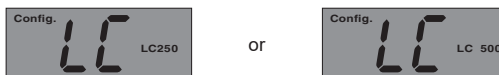

figure 18

ATTENTION!
Whenever a PRO LC is removed from the lubricator and is replaced by another PRO LC, the control system assumes that a new, completely filled PRO LC was attached.
Therefore NEVER attach a PRO LC that is not completely full!

6.2 How to Replace the PRO LC

Drive system and circuit board must be protected from moisture. Exchanges should only be done in a dry place and it must be ensured that no moisture enters the drive unit.

- a) Turn the protection cover on the drive unit counter-clockwise and remove it.
- b) Remove the empty PRO LC. The display indicates "LC" and the red LED is blinking.
- c) Remove the used battery PRO B from the drive unit.
- d) Insert the new battery PRO B into the drive unit. Follow the directions of the arrows.
- e) Remove the plug of the PRO LC (refer to figure 5, chapter 3.2).
- f) Push the PRO LC into the protection cover until lubricant comes out of the opening (refer to figure 6, chapter 3.2).
- g) Place the new PRO LC on the drive unit, turn it until the catch locks and the teeth of the PRO LC and the drive unit interlock. The control system automatically recognizes the new PRO LC.
The display indicates "--", if the perma PRO was *switched off* prior to the replacement of the PRO LC
Or it indicates "99 % Vol.", if the perma PRO was *switched on* before the replacement.
You should only use completely full perma-tec PRO LC, in order to guarantee a trouble-free operation.
- h) The lubrication system continues to operate with the previous setting of the discharge period.
- i) If required, change lubricator settings (see chapter 5.8).



If the lubricator was ON before changing the PRO LC, it will automatically resume operation with existing settings. If the lubricator was OFF, it must be turned ON (refer to figure 13, chapter 5.5).

7. Trouble Shooting

7.1 Error Messages on the Display

Possible errors of the lubrication system and the application are detected by the electronic control system and are indicated on the display. If an error is displayed, the system is switched OFF until the cause of the error has been eliminated and the error message has been acknowledged.



Error messages are acknowledged and reset by pushing the ON/OFF/SELECT button. However, error messages “*LC*” and “*Lo*” are automatically acknowledged when errors are corrected (see remedial measures).

7.2 Trouble Shooting Guide

If there are malfunctions during the operation of the lubrication system, please check for possible causes using the following chart (refer to chart 7).

Every time that an error message is displayed, the red LED is also blinking.

Indication of the display	Error	Possible cause	Remedial measures
<i>E1</i>	Lubricator has been switched off	Excess motor current of the lubricator motor due to a blocked outlet Battery PRO B is empty	Clear the blockage and acknowledge the fault by pushing and holding down the ON/OFF/SELECT button Insert a new battery PRO B and use a full PRO LC
<i>E4</i>	Lubricator has been switched off	Drive mechanism is defective	Exchange the drive unit
<i>LC</i>	System does not detect the PRO LC.	No PRO LC installed	Install an PRO LC
<i>Lo</i>	No power supplied to the system from the battery	No battery PRO B inserted or battery PRO B empty	Insert a new battery PRO B and use a full PRO LC
No display	System gets no power from internal back-up battery	Internal back-up battery empty	Replace the drive unit of the lubricator
In addition to the above, the following malfunctions can occur when a perma distributor PRO MP-6 is connected to the lubrication system:			
<i>E0</i>	Lubrication system has been switched off	Excess motor current of the perma distributor MP-6	Replace perma distributor PRO MP-6
<i>F1 to F5</i>	Error at the displayed lubrication point	Excess motor current of the lubricator motor caused by a blocking of the displayed outlet	Clear the blockage and acknowledge the fault by pushing and holding down the ON/OFF/SELECT button
<i>E2</i>	Lubrication system has been switched off	Outlets of distributor not correctly recognized	Replace distributor
<i>E3</i>	Lubrication system has been switched off	Timeout while activating distributor	Replace distributor
		Connection cable damaged	Replace connection cable
<i>E5</i>	Outlet configuration missing	Outlets were not activated	Activate desired outlets

chart 7

8. Disposal



Help us in protecting the environment and saving resources by recycling valuable raw material. Please follow your local waste disposal regulations.

9. Service

Please contact your local supplier for availability and cost of the following:

- ◆ Returning of the empty lubricator for environmentally safe recycling or disposal.

or:

- ◆ exchange of battery PRO B.
- ◆ exchange of PRO LC.
- ◆ to pre-set lubricator (LC / lubrication period / outlets)

Translation of the Original Operating Instructions
perma PRO C 250 / 500



The Expert in Lubrications Solutions



Lubrication System perma PRO C

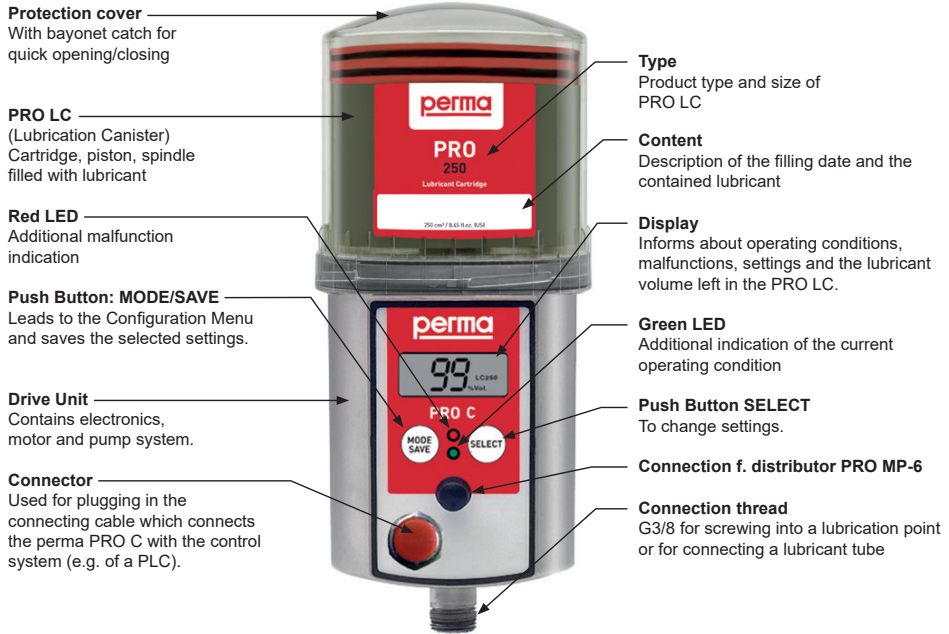

Display

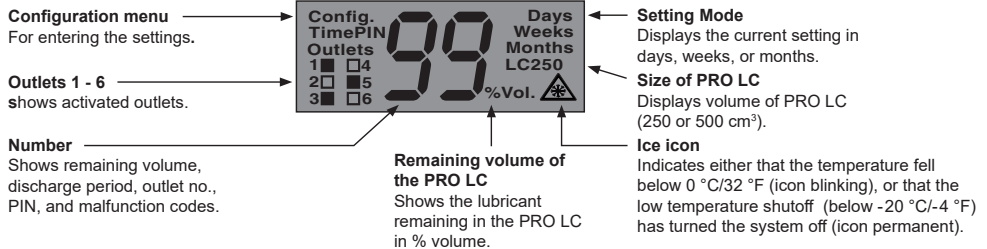

Drive Unit

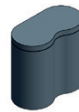
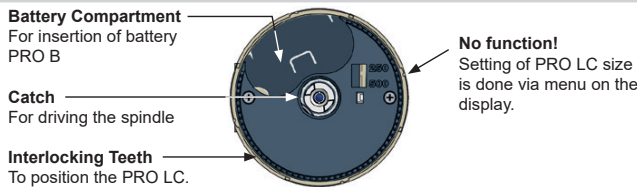

Battery PRO B (back-up battery)

Connecting Cable

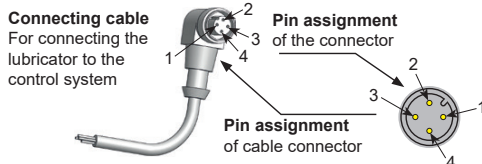

Pin-number	Strand color	Function
1	brown	Not assigned
2	white	Malfunction
3	blue	Ground
4	black	Voltage

Quick Reference Guide for the Lubrication System perma PRO C

On this page you will find some important information for quick and easy operation and setting of the perma PRO C lubrication system. Before the first installation of the perma PRO C and whenever you need detailed instructions, you should read the complete Operating Manual which contains information that must be observed. Make sure to follow the instructions giving in the chapter "Safety Instructions".

1 Assembly of perma PRO C / Exchange of PRO LC (refer to chapter 3 and 6)

- ◆ Mount the drive unit on the mounting plate and secure it with the three pre-drilled holes (see attached template).
- ◆ Insert a battery PRO B (back-up battery) into the battery compartment (follow directions of the arrows).
- ◆ Place the PRO LC inside the cover and remove the plug of the PRO LC.
- ◆ Push the PRO LC into the cover until lubricant comes out of the opening.
- ◆ Place the PRO LC with its cover on the drive unit. Make sure that the catch locks and that the teeth of PRO LC and drive unit interlock.
- ◆ Turn the cover clockwise until the bayonet catch locks.
- ◆ Connect the perma PRO C to your control system using the connecting cable.

2 Determine the Discharge Period (refer to chapter 5.7)

- ◆ Refer to the manufacturer's guidelines about the lubrication point that you want to lubricate in order to determine the required lubricant amount in cm³ per one hundred operating hours.
- ◆ Refer to chart (chapter 5.7, chart 5) and find your required lubrication volume. Based on that, the chart will show you the required PRO LC size, the setting of the discharge period, and the setting mode.

3 Setting of PRO LC Size, Discharge Period, Outlets and PIN (refer to chapter 5.8)

- ◆ Hold down the MODE/SAVE button until the set time is displayed.
- ◆ Hold down the MODE/SAVE button again until you reach the current PIN (PIN cannot be changed here / PIN setting at delivery is "00").
- ◆ Hold down the MODE/SAVE button again until you reach the other setting menus: PRO LC, discharge period, outlets (only with attached MP-6), and PIN change. Change settings with a short push of MODE/SAVE or SELECT.

4 Impulse Mode via the Connected Control System (refer to chapter Kap. 5.10)

- ◆ To start the impulse mode, set the setting mode "Days" in the configuration menu of the lubricator to "00".
- ◆ Trigger a discharge with a discharge volume of 0.5 cm³ by switching on the supply voltage for the perma PRO C for a minimum operating period of 14 minutes.
- ◆ The minimum shutdown period between two discharges is 20 seconds.

5 Save Settings (refer to chapter 5.8)

- ◆ Keep the MODE/SAVE button pressed until display shows "--".

6 Starting perma PRO C (refer to chapter 3.3 and Kap. 5.5)

- ◆ Switch on the supply voltage (DC 15 V to 30 V) for the lubricator via your control system. The remaining volume is displayed and the green LED is blinking.

7 Stopping perma PRO C (refer to chapter 5.6)

- ◆ Switch off the supply voltage for the lubricator. The display of the lubricator shows "--".



1. General Information

1.1 Delivery / Content

- ◆ perma PRO C will be delivered according to customer specifications in regards to type of grease and size/content of PRO LC. You only have to assemble it and connect it to your control system (e.g. a PLC) using the connecting cable. Furthermore, you have to set the required discharge period at the lubricator and connect the perma PRO C to the supply voltage.
- ◆ Connecting cable for connecting lubricator and control system.
- ◆ Mounting device and screws included.
- ◆ Battery PRO B (back-up battery)
- ◆ Operating instructions and EC Conformity declaration included.
- ◆ Upon delivery, make sure to check if the delivered goods correspond to your order.
perma-tec GmbH & Co. KG will not accept liability for subsequent claims of any shortcomings.
- ◆ Please immediately forward any claims:
 - of noticeable transport damage directly to the forwarder.
 - of noticeable faults, shortcomings or defects directly to your perma distributor.

1.2 Storage

When the lubricators are not immediately installed, you must ensure appropriate storage conditions in dry, dust free places with a temperature of $+20\text{ °C} \pm 5\text{ °C}$ ($+68\text{ °F} \pm 9\text{ °F}$). Make sure that PRO LC and battery PRO B are not stored longer than one year.

For drive unit (1) protection during storage: Do not remove protection cover (2), disc (3), and plug (4) until you are ready to install the system (see chapter 5.2).

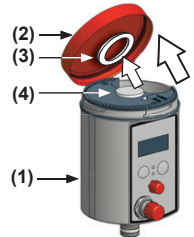

1.3 Markings

- ◆ The lubricator perma PRO C is clearly marked with a label on the drive system (serial number) and a label on the PRO LC.
- ◆ **CE mark** on the drive unit
- ◆ **EAC mark** on packaging
- ◆ Manufacturer:
perma-tec GmbH & Co. KG
Hammelburger Straße 21
97717 Euerdorf
Germany
Tel: +49 (0) 9704 609-0
Fax: +49 (0) 9704 609-50
- E-mail: info@perma-tec.com
- Web page: www.perma-tec.com

1.4 Intended Usage

The lubricator perma PRO C

- ◆ immediately supplies all lubrication points with lubricant, at a **pressure build-up of max. 25 bar** (360 psi), consistently, precisely and independent of temperature;
- ◆ can be used for all lubrication points of sliding- and roller bearings, drive- and transport chains, sliding guideways, open gears and seals;
- ◆ **must** be used with a suitable protection box (refer to "Accessories and Spare Parts") if operated outside or around splashing water;
- ◆ can be connected to the control system (e.g. PLC) of your machine;
- ◆ must be provided with the supply voltage from your equipment;
- ◆ should only be connected to/used with original lubrication tubes from perma-tec GmbH & Co. KG;
- ◆ is intended for use on machinery and equipment;
- ◆ is only to be used for the ordered purpose and purposes confirmed by perma-tec GmbH & Co. KG;
- ◆ is only to be used for operating conditions recommended in this operating manual;
- ◆ is only to be used with settings and variations recommended in this operating manual.



DO NOT USE in explosive areas!



Any other usage, setting, addition, and variation is considered to be inappropriate!



2. Technical Data

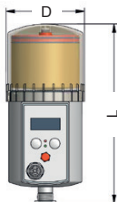

	PRO C 250	PRO C 500
Volume of the PRO LC	250 cm ³	500 cm ³
Length (L)	210 mm	260 mm
Diameter (D)	92 mm	92 mm
Weight, empty	1.30 kg	1.37 kg
Weight, filled with perma High performance grease SF04	1.53 kg	1.82 kg
Discharge period	1 day to 24 months	1 day to 24 months
Discharged volume per lubrication impulse	0.5 cm ³	
Application temperature	-20 °C to +60 °C / -4 °F to +140 °F	
Maximum pressure build-up	25 bar (360 psi)	Combination of these Maximum-Values can only be realized by temperatures of ≥ 20 °C / 68 °F. At lower temperatures, the application is limited according to the diagram below.
Maximum tube length (inner-Ø 5 mm)	5 m	
Lubricants	Greases up to rated consistency NLGI 2	
Power supply	15 V (DC) to 30 V (DC)	
Typ. power consumption	120 mA (Current at make can be up to 1.3 A!)	
Max. switching current (error output)	1 A	
Length of the 4 - pole connecting cable (Standard)	5 m	
Back-up battery	Battery PRO B (3 V alkaline manganese, not rechargeable)	
Emission sound pressure level	< 70 dB(A)	
Connection thread	G3/8	



figure 1

chart 1

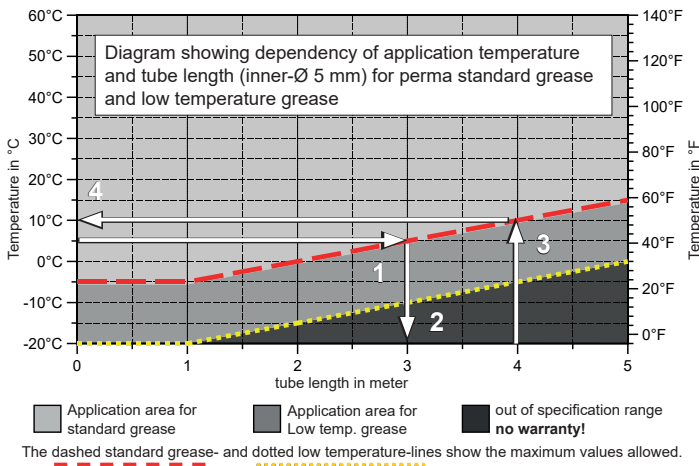

If your application is out of the specification range shown in this diagram, please contact your local distributor. perma-tec cannot be held liable for these applications.

Example:

1. The application temperature is +5 °C/+41 °F. What is the maximum tube length allowed for standard grease?
Correct Answer: 3 m max. tube length for standard grease, 5 m max. tube length for low temp. grease (arrow 1 meets the dashed line of the standard grease range at 3 m).
2. You want to use a 4 m tube. Up to which temperature can the system be used?
Correct Answer: +10 °C/50 °F with standard grease -5 °C/23 °F with low temp. grease (arrow 3 meets the dotted line of low temp. grease at the -5 °C mark; and the dashed line of the standard grease at the +10 °C mark).

2.1 Design of the PRO C Lubricator

Lubricators are available as 250 cm³ and 500 cm³ versions and they can be supplied with the lubricant requested by the customer. They consist of (refer to figure 2):

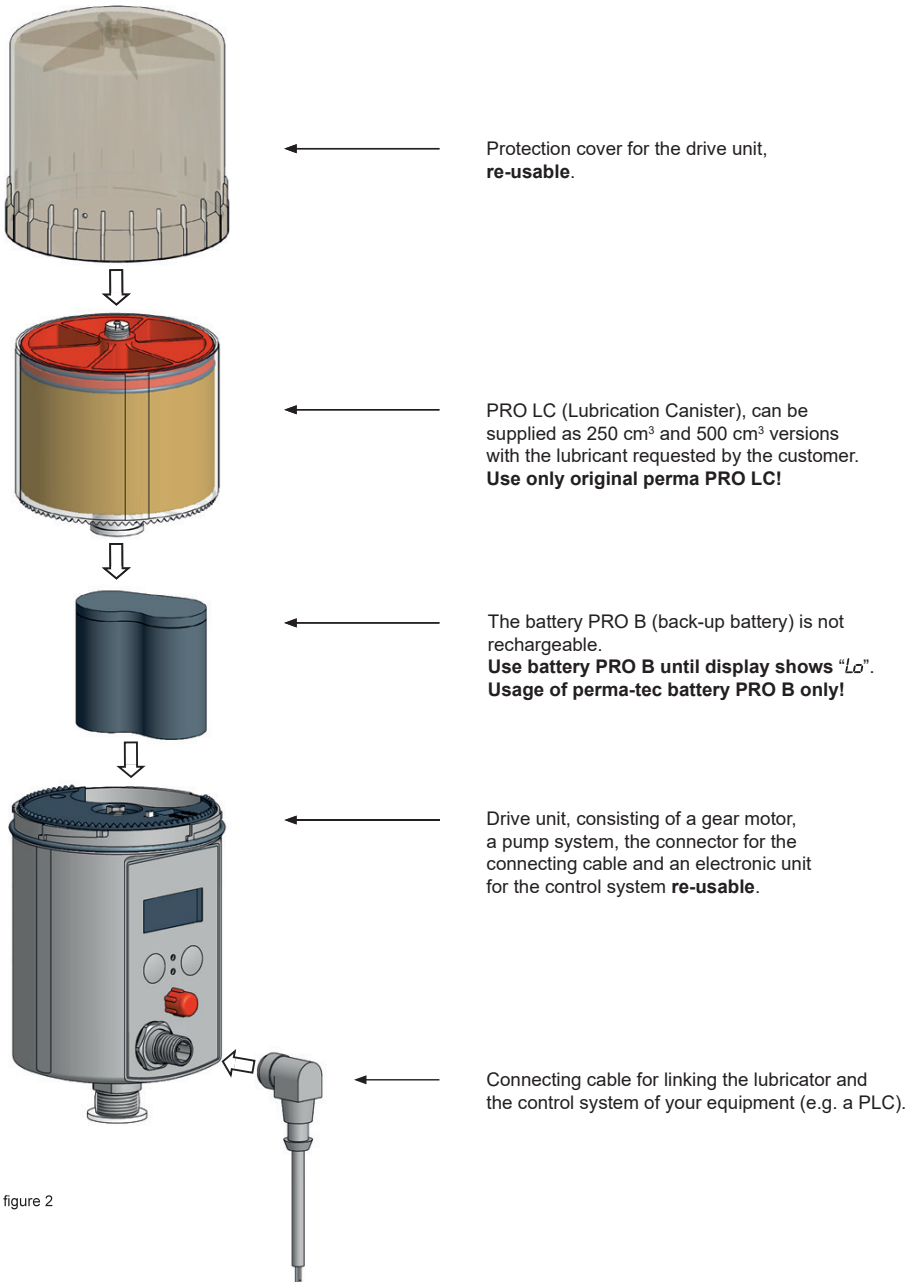



figure 2

3. Mounting and Assembly of the Lubrication System

3.1 Mounting the Drive Unit onto a Fixing Device for Wall-Mounting

- ◆ Attach the supplied mounting device to the drive unit using the two enclosed hex head bolts (M6 x 16) and the two washers.
- ◆ Screw the mounting device with the drive unit onto a support of your system. The boring template of the three mounting screws (141.5 x 45) can be seen below in figure 3 or on the template that is included. You have to use at least three hexagon screws M6 x 25 (e.g. on metal ground).
- ◆ Before you connect the outlet of the drive unit to the lubricant tube, you have to make sure that the lubrication points and the complete lubricant tube is pre-lubricated with the same lubricant that is contained in the PRO LC. For that, perma-tec offers a 400 g lubrication cartridge for manually-operated grease presses with the requested lubricant.
- ◆ Connect the lubricant tube (connection G3/8) to the outlet of the drive unit and install the tube correctly between the outlet and the lubrication point. The lubricant tube must not be longer than five meters.

 **Make sure that you assemble the connections and lubricant tubes correctly and tightly to avoid possible leakage.**

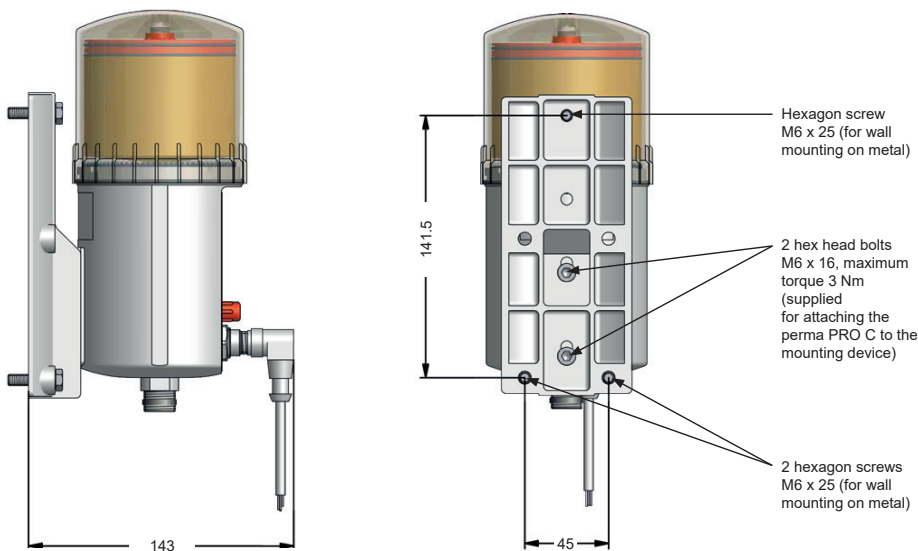

figure 3

3.2 Assembly of the Lubricator

a)

- ◆ Place the PRO LC inside the protection cover and remove the plug of the PRO LC (refer to figure 4).

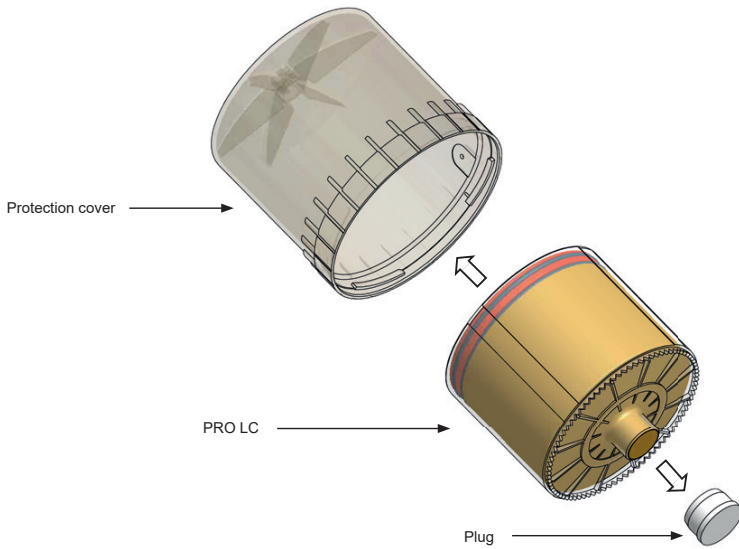

figure 4

b)

- ◆ Push the PRO LC into the protection cover until lubricant comes out of the opening (refer to figure 5).

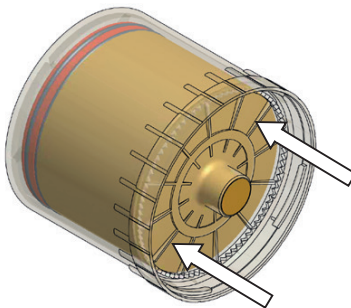

figure 5

c)

- ◆ Insert the battery PRO B into the drive unit (according to the direction of the arrow on the label).
- ◆ Place the PRO LC with its protection cover on the drive unit. Make sure that the catch locks and that the teeth of the PRO LC and the drive unit interlock (refer to figure 6).
- ◆ Turn the cover clockwise until the bayonet catch locks.

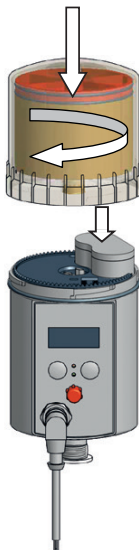
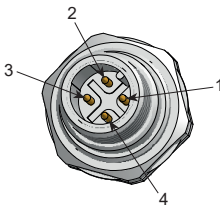

figure 6

3.3 Connect the Connecting Cable to the Lubricator

- ◆ Connect the four strands of the connecting cable to the control system (e.g. a PLC) of your equipment and pay attention to the pin assignment of the connector on the lubricator (refer to chart 2 and figure 7).
- ◆ Insulate the connected strands correctly.
- ◆ Insert the 4-pole connecting cable into the connector of the lubricator (refer to figure 6).
- ◆ Screw tight the connector socket of the connecting to the connector of the lubricator.



Pin assignment of the connector on the lubricator

figure 7

Pin no. of the connector on the lubricator	Strand color of the standard cable	Function
1	brown	Not assigned
2	white	Malfunction*
3	blue	Ground
4	black	Voltage (15 V to 30 V – DC)

chart 2



* Error signal is low-active! (negative logic)

4. Display and Control Elements of the Lubrication System

4.1 Display Elements

The operating status of the lubricator can be determined via the green or the red LED and via the display at the control unit (refer to figure 8) of the perma PRO C.

The perma PRO C offers a menu-guided setting. Changes of the settings are shown on the display. Error messages, e.g. in case the pressure in the lubricant tube gets too high, are also indicated on the display.



figure 8

4.2 Function Indication on the Display

The display is located on the control unit of the perma PRO C (refer to figure 8, chapter 4.1). The display shows settings, operating conditions and error messages of the lubricator.

In case of an error free operation of the lubrication system, the display shows the remaining volume of the mounted PRO LC in percent volume (% Vol.). Figure 9 shows an example of the displayed information if the PRO LC 500 is new and full.



figure 9

The display cannot be turned off when a PRO LC is attached and a battery PRO B (back-up battery) is inserted. If the lubrication system is switched off, the display will always show two lines (see figure 10 below).



figure 10

4.3 Function Indication via the LEDs

LED	Signal	Signal Length	Explanation
green	flash	every 10 seconds	operation (OK)
red	flash	every 3 seconds	error / malfunction
green and red	flash	every 3 seconds	PRO LC empty
green	light	permanently	Lubricator is discharging

chart 3

4.4 Function Indication via the Connected Control System

The connected control system of your equipment can only indicate that the lubricator is working, or that there is a malfunction. If the perma PRO C is working, the control system receives a "High" signal and for a malfunction a "Low" signal.

4.5 Control Buttons

There are two push-buttons on the control unit (refer to figure 8) which can be used for a menu-guided change of the settings.

- ◆ With the MODE/SAVE button (refer to figure 11) you can reach the configuration menu, change the mode and save the modified settings for further operation.
- ◆ With the SELECT button (refer to figure 12) you can do the following: increase discharge period (Days, Weeks, Months - each time you press the button increases the discharge period by one calendar unit), change PRO LC size, activate MP-6 outlets and set PIN.





PRESS	Short	Short	Long > 4 sec. until the display content changes completely	Long > 4 sec. until the display content changes completely
BUTTON	 figure 11	 figure 12	 figure 11	 figure 12
FUNCTION	Selection in current display	Changing of values	Moves to new menu and saves selected values	Returns to original menu without saving changes

chart 4, figure 11, figure 12

5. Operation and Control

5.1 Preparations

- ◆ Prior to the installation of the lubricator, the lubrication point and the complete connection tube must be sufficiently pre-lubricated with the same lubricant that the PRO LC contains. For this, perma-tec offers a 400 g lubrication cartridge for grease presses with the corresponding lubricant (refer to "Accessories and Spare Parts").
- ◆ When installing the perma PRO C, the supplied perma-tec mounting device should be used.
- ◆ When connecting the perma PRO C to your control system, the supplied perma-tec connecting cable should be used. This connection may only be established by qualified personnel.
- ◆ The lubricant tube must be installed and mounted correctly. The length of the lubricant tube may not exceed a maximum of 5 meters and the tube must be a perma-tec product.
- ◆ Please check if the thread of the perma PRO C (G3/8) corresponds to the connection thread of the lubrication point. If this is not the case, you can order a corresponding reducer or other parts from the perma accessory line.

 **During initial operation, the perma PRO C drive is filled with perma Food grade grease H1 SF10. Please press "additional discharge" repeatedly in order to exchange the lubricant in the drive until the lubricant inside the LC is discharged at the drive outlet (refer to chapter 5.8).**

5.2 Prior to Operation

- ◆ Check all parts of the lubricator for obvious damages!
- ◆ Is the new PRO LC filled with the required lubricant?
- ◆ Did you insert a battery PRO B (back-up battery)?
- ◆ Is the connecting cable connected to the control system of your equipment and is the supply voltage (DC 15 V to 30 V) applied?
- ◆ Did you remove protection cover, disc and plug from drive unit (see chapter 1.2)?
- ◆ Did you assemble and mount all of the parts correctly and tightly?

5.3 Setting into Operation

- ◆ Mount the drive unit onto a fixing device for wall-mounting (refer to chapter 3.1).
- ◆ Insert the battery PRO B into the drive unit and the PRO LC into the protection cover and close the complete system (refer to chapter 3.2).
- ◆ Determine the discharge period (refer to chapter 5.7).
- ◆ Set volume of PRO LC, discharge period, outlets of MP-6, and the PIN via buttons on display (refer to chapter 5.8) or set the lubricator to impulse mode (refer to chapter 5.10).
- ◆ Plug the connecting cable into the lubricator and connect the strands to your control system (refer to chapter 3.3).
- ◆ Turn the lubrication system on by supplying voltage (refer to chapter 5.5).
- ◆ Carry out an additional discharge (refer to chapter 5.8).
If the drive motor has started and the green LED is lit, the lubricator has started to discharge. The display indicates the remaining volume (% Vol.) of the PRO LC.



The operator must always check the customer-specific settings and if necessary change them before the lubricator is set into operation!

5.4 During Operation

- ◆ Carry out regular inspections during the operation. You should pay special attention with regard to leakage and to the condition of the lubricator!
- ◆ Check the condition of the lubricant tube and the connections regularly!
- ◆ Check the filling level of the transparent PRO LC regularly!
- ◆ After one or several additional discharges, you have to calculate the reduced discharge period and note this on your lubrication and maintenance schedule.
- ◆ If your control system indicates a malfunction, you have to determine its cause directly via the display of the perma PRO C. You can check for possible causes using the trouble shooting guide (refer to chart 8, chapter 7.3). If the fault cannot be fixed, please contact your local supplier for technical support.



Additional discharges and long machine standstills must always be taken into account with regard to the remaining discharge period of the lubricator.

5.5 Switching the Lubrication System On

To turn the lubrication system on, you have to switch on the supply voltage for the perma PRO C. The indication (“--”) on the display is replaced by an indication of the remaining volume – e.g. 99 % VOL (with a new PRO LC) (see figure 13). The green LED starts blinking and the malfunction output sends a “High” signal (system OK) to the connected control system.



Switch-on of the supply voltage by the control system



figure 13

5.6 Switching the Lubrication System Off

To switch the lubrication system off (refer to figure 14) you have to switch off the supply voltage of the perma PRO C. The display no longer indicates the remaining volume – % VOL – but indicates (“--”) instead. When the lubrication system is switched off, all of the settings are saved. This means that if you start the lubricator again, it will take up the operation at the point where it had been switched off. The fault output sends a “Low” signal (system not working) to the control system.



figure 14

5.7 Determining the Discharge Period Without Impulse Mode



The discharge period is automatically factory-set to six months according to the supplied PRO LC. Upon request, a factory-setting of the discharge period required by the customer is also possible. The size of the PRO LC is taken into account.

If you want to determine the discharge period, you need to know the required amount of the lubricant in cubic centimeters for 100 operating hours (cm³/100 h). This information can be taken from the technical documents of the manufacturer of the lubrication point. With this information, you can determine the discharge period using the following chart (chart 5).

		Average discharge volume in cm ³ per 100 operating hours					
PRO LC		250			500		
Setting point Discharge period	Setting mode	Days	Weeks	Months	Days	Weeks	Months
	1		1041.7	148.8	34.3	2083.3	297.6
2		520.8	74.4	17.1	1041.7	148.8	34.3
3		347.2	49.6	11.4	694.4	99.2	22.8
4		260.4	37.2	8.6	520.8	74.4	17.1
5		208.3	29.8	6.9	416.7	59.5	13.7
6		173.6	24.8	5.7	347.2	49.6	11.4
7		148.8	21.3	4.9	297.6	42.5	9.8
8		130.2	18.6	4.3	260.4	37.2	8.6
9		115.7	16.5	3.8	231.5	33.1	7.6
10		104.2	14.9	3.4	208.3	29.8	6.9
11		94.7	13.5	3.1	189.4	27.1	6.2
12		86.8	12.4	2.9	173.6	24.8	5.7
13		80.1	11.4	2.6	160.3	22.9	5.3
14		74.4	10.6	2.4	148.8	21.3	4.9
15		69.4	9.9	2.3	138.9	19.8	4.6
16		65.1	9.3	2.1	130.2	18.6	4.3
17		61.3	8.8	2.0	122.5	17.5	4.0
18		57.9	8.3	1.9	115.7	16.5	3.8
19		54.8	7.8	1.8	109.6	15.7	3.6
20		52.1	7.4	1.7	104.2	14.9	3.4
21		49.6	7.1	1.6	99.2	14.2	3.3
22		47.3	6.8	1.6	94.7	13.5	3.1
23		45.3	6.5	1.5	90.6	12.9	3.0
24		43.4	6.2	1.4	86.8	12.4	2.8
25		41.7	--	--	83.3	--	--
26		40.1	--	--	80.1	--	--
27		38.6	--	--	77.2	--	--
28		37.2	--	--	74.4	--	--
29		35.9	--	--	71.8	--	--
30		34.7	--	--	69.4	--	--

chart 5



Please take into account that in case of one or several additional discharges, the remaining discharge period of the lubrication system must be recalculated (refer to chapter 5.9). This also applies in case of a cut-off of the lubrication system due to a long machine standstill (e.g. weekends or annual holidays). You should also note the result of your calculation of the remaining discharge period in your lubrication and maintenance schedule.

5.8 Settings and Display for perma PRO C (+ Distributor PRO MP-6)
(see caption on page 35)

MODE SAVE	Display	SELECT	Meaning/Description	
	--		Display at delivery with attached PRO LC	
↓ MODE SAVE	Time 06 Months		Shows discharge period PIN-reset	Info
↓ MODE SAVE	PIN 00	Change first digit ↓ SELECT	Enter first digit of current PIN PIN "00" at delivery	PIN-Entry
↓ MODE SAVE	PIN 00	Change second digit ↓ SELECT	Enter second digit of current PIN	
↓ MODE SAVE	Config. LC LC 500	Change from LC500 to LC250 ↓ SELECT	Set PRO LC size	LC
↓ MODE SAVE	Config. Time 06 Months	Change months ↓ SELECT	Set discharge period: Months <u>or</u> Weeks <u>or</u> Days	Time
↓ MODE SAVE	Config. Time 01 Weeks	Change days or weeks ↓ SELECT	Set discharge period: Go to "Days" or "Weeks"	
↓ MODE SAVE	Config. 1 Outlets 1 <input type="checkbox"/> 4 2 <input type="checkbox"/> 5 3 <input type="checkbox"/> 6	Outlet 1 On / Off ↓ SELECT	Activate outlets: Activate outlet 1 Outlets only displayed if MP-6 is connected	Outlets
	Config. 1 Outlets 1 <input checked="" type="checkbox"/> 4 2 <input type="checkbox"/> 5 3 <input type="checkbox"/> 6		Outlet 1 activated	
↓ MODE SAVE	Config. 2 Outlets 1 <input type="checkbox"/> 4 2 <input checked="" type="checkbox"/> 5 3 <input type="checkbox"/> 6	Outlet 2 On / Off ↓ SELECT	Outlet 2 activated (if desired, other outlets may be turned On / Off the same way)	
↓ MODE SAVE ↓ MODE SAVE	Config. PIN 00	Change first digit ↓ SELECT	PIN (first digit) enter for initial configuration or after a PIN-reset – otherwise, setting is complete	PIN
↓ MODE SAVE	Config. PIN 00	Change second digit ↓ SELECT	PIN (second digit) enter for initial configuration or after a PIN-reset	
↓ MODE SAVE	--		Configuration finished	

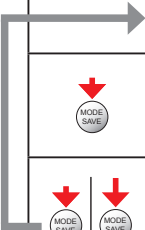

C O N F I G U R A T I O N M E N U

chart 6

Caption for Chart on Left Side

Instructions should be followed from top to bottom and from left to right (also refer to chart 4). The instructions correspond to the operating sequence on the turned off lubrication system perma PRO C. Configuration is also possible if perma PRO C is On.

Function	short push	long push	blinking display	go to
Symbol	↓	↓	⋮	→

chart 7

CONFIGURATION SECTIONS (see vertical bar, chart 6)

I N T R O

INTRO informs **Info** and asks for the current PIN. **PIN Entry**

C O N F I G U R A T I O N M E N U E

Settings can be changed in the configuration menu with its different sections (LC, Time, Outlets, PIN).

LC

You can change the PRO LC size from LC250 to LC500 and back by pushing the SELECT button (refer to chapter 6.1 and 6.2).

Time

The discharge period can only be set in **one** type of calendar unit (i.e. either Months, Weeks, or Days). When the highest unit is reached, counting starts again with number "0" (except with days "00" = Impulse Mode, refer to chapter 5.10).

Outlets

The activated outlets 1 - 6 are displayed with a filled in square in the display (please refer to the operating instruction of the MP-6 distributor for more details). If no distributor is connected, configuration of outlets has no effect.

PIN

We strongly suggest to enter a personal PIN in order to protect your settings from unauthorized access. The PIN can **only be changed during initial configuration or after a PIN-reset**. A PIN-reset (short push of buttons: left-left-right-right-left in the INTRO-Info-menu) changes your personal PIN back to "00". The PIN-reset was successful when the displayed time disappears for a second and then comes back on. All other settings remain unchanged.

Save or Reject Changed Settings

The display settings can be saved with a long push of the MODE/SAVE button. If you do **not** want to save your changes to setting that are currently displayed in the configuration menu (LC, Time, Outlets, PIN), press the SELECT button until the display shows either ("--") for Off or the remaining volume of the PRO LC in % VOL. All other settings and already saved changes remain valid.

Automatic Termination of the Configuration Mode

If you do not press a button in the configuration mode for 180 seconds, the control system is automatically switching back to the previously set mode ("On" or "Off") without saving the changes. The settings existing prior to the change remain valid.

Additional Discharge

With an additional discharge, a lubrication point can be supplied with an additional amount of the lubricant. For an additional discharge, the lubrication system must be switched on (display shows the remaining volume) and both buttons must be held down simultaneously (refer to figure 15).



figure 15

Lubricator On



For an additional discharge, press both buttons at the same time and hold them down (> 4 sec.)

An additional discharge is only possible at temperatures above 0 °C / 32 °F (figure 16, ice crystal is not visible) and when the lubrication system is not currently conducting a regular discharge.

Every additional discharge reduces the remaining discharge period since an increased amount of the lubricant has been supplied. This must be taken into account in your lubrication and maintenance schedule.



The time between two additional discharges is at least 30 seconds. Each additional long push of both buttons (simultaneously) (figure 15) during this time is being registered and will lead to even more additional discharges. The system remembers a max. of 5 additional discharges.

Low-Temperature Cut-Off of the Lubrication System

The temperature range from 0 °C to -19 °C (32 °F to -2.2 °F) is indicated by a blinking ice crystal symbol (refer to figure 16).

In this temperature range the lubrication system perma PRO C continues to operate without interruption.

Please note, that in this temperature range an additional discharge is not possible!



figure 16

Display with a blinking ice crystal (in this example with 89 % Vol.)

In order to protect the system from damage, the low-temperature cut-off of the lubrication system is automatically carried out by the control system and the built-in temperature sensor.

If the temperature reaches or falls below -20 °C (-4 °F), the lubricator is switched off by the low-temperature cut-off and the ice crystal symbol is permanently indicated on the display. The remaining volume is still displayed in % Vol.



From this time onwards, the lubricant is no longer discharged. You have to take this fact into account if your system continues to operate in order to prevent damages!

As soon as the temperature rises and reaches -19 °C (-2.2 °F) or higher, the control system switches the lubrication system on again. The display shows the remaining volume and the blinking ice icon.



All discharges (except discharges in Impulse Mode and additional discharges), accumulated during the shut-off, will be caught up when the system continues operation (at a max. of two additional discharges with every regular discharge).

5.9 Calculation of the Remaining Discharge Period



Please note, that in case of one or several additional discharges, the remaining discharge period of the lubrication system must be recalculated. This also applies in case of a cut-off of the lubrication system due to a long machine standstill (e.g. weekends or annual holidays) or in case of a low-temperature cut-off carried out by the system if temperatures reach -20 °C (-4 °F).

You should also note the result of your calculation of the remaining discharge period in your lubrication and maintenance schedule.

If you have set the perma PRO C to impulse mode, you cannot calculate the remaining discharge period since the value for the set discharge period (SDP) is not available.

In this case, you have to pay attention to the information on the display of the lubricator and to the information indicated by the connected control system.

$$\text{Formula: } R_{DP} = \frac{\text{SDP} * \text{RV}}{100}$$

SDP: Set Discharge Period of the lubricator (days, weeks, months)

RV: Remaining Volume (displayed in % Vol.)

R_{DP} : Remaining discharge period (days, weeks, months depending on SDP)

Example of a Calculation of the Remaining Discharge Period

The perma PRO C with a 250 cm³ PRO LC was originally set to a discharge period (SDP) of eight months, since the lubrication point needs 4.3 cm³ lubricant/100 h. After two months, the perma PRO C indicates a remaining volume (RV) of 75 % Vol. At this point, the lubricator is switched off for six weeks (e.g. machine standstill). When it is switched on again, you would like to determine when the PRO LC will be empty.

$$R_{DP} = \frac{\text{SDP} * \text{RV}}{100} = \frac{8 * 75}{100} = \frac{600}{100} = 6$$

This results in a remaining discharge period of six months. After these six months, the PRO LC will be empty and must be replaced by a new one.

5.10 Impulse Mode via the Connected Control System

Discharge of lubricator PRO C can also be triggered via the attached control system.

In this case, the lubricator discharges 0.5 cm³ lubricant to the lubrication point every time it is switched on. For this, you have to switch on the supply voltage via your control system for at least 14 minutes and then you have to switch it off for at least 20 seconds.

The minimum operating time of 14 minutes is due to the possibility to connect the perma PRO C to the distributor perma MP-6. This distributor is able to supply lubricant to up to six lubrication points.

This means that the distributor needs a minimum operating time of 14 minutes to be able to supply 1.0 cm³ lubricant to every open distributor outlet.

If operated as a single-point lubrication system, the minimum operating time is reduced to 1 minute and the discharge amount per impulse = 0.5 cm³.

For an activation of the perma PRO C lubricator via your control system, you need to set the lubricator to impulse mode via the configuration menu (refer to chapter 5.8).

For this, you have to select the setting "00" Days in the setting mode "Days" (refer to figure 17).



figure 17

6. Replacement of the PRO LC

The Following Must Always Be Taken into Account

If the replacement of an empty PRO LC becomes necessary, it will be indicated by a simultaneous blinking of the red and the green LED. Additionally, the display indicates that the PRO LC is empty (refer to figure 18).

If the PRO LC is empty, the connected control system of your equipment receives a "Low" signal and a malfunction is indicated.



figure 18



If you replace the PRO LC by an PRO LC of a different size, a corresponding protection cover (refer to "Accessories and Spare Parts") must be used.



Since the drive unit and the control board must be protected against moisture, an exchange may only be carried out in dry conditions!

After the installation of the new PRO LC, the control system continues to operate using the previously valid setting of the discharge period.

6.1 Setting the Volume of the PRO LC

The size of the PRO LC must be set in the configuration menu with the two buttons on the drive unit (refer to figure 19). Please also refer to the operating chart (chart 6, chapter 5.8).



ATTENTION!

If the displayed setting does not correspond with the attached PRO LC size it will result in incorrect discharge amounts and wrong signals in the display (Display, LEDs).

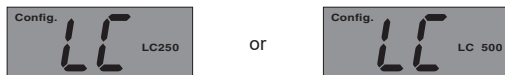

figure 19



ATTENTION!

Whenever a PRO LC is removed from the lubricator and is replaced by another PRO LC, the control system assumes that a new, completely filled PRO LC was attached.

Therefore NEVER attach a PRO LC that is not completely full!

6.2 How to Replace the PRO LC

Drive system and circuit board must be protected from moisture. Exchanges should only be done in a dry place and it must be ensured that no moisture enters the drive unit.

- a) Turn the protection cover on the drive unit counter-clockwise and take it off.
- b) Remove the empty PRO LC. The display indicates "LL" and the red LED is blinking.
- c) Use battery PRO B until display shows „Lo“ (see chapt. 7).
- d) Remove the plug of the PRO LC (refer to figure 4, chapter 3.2).
- e) Push the PRO LC into the protection cover until lubricant comes out of the opening (refer to figure 5, chapter 3.2).
- f) Place a new PRO LC on the drive unit, turn it until the catch locks and the teeth of the PRO LC and the drive unit interlock.
The control system of the perma PRO C automatically recognizes the new PRO LC and the display indicates "--", if the perma PRO C was *switched off* prior to the replacement of the PRO LC.
Or it indicates "99 % Vol.", if the perma PRO C was *switched on* before the replacement.
You should only use completely full perma PRO LC in order to guarantee a trouble-free operation.
- g) The lubrication system continues to operate with the previous setting of the discharge period.
- h) If required, change lubricator settings. Refer to chapter 5.8 or to chapter 5.10 in case of an impulse mode of the lubricator.



If the lubricator was ON before changing the PRO LC, it will automatically resume operation with existing settings. If the lubricator was turned Off, it must be turned On again by supplying voltage (refer to chapter 5.5).

7. Trouble Shooting

7.1 Error Messages on the Display

Possible errors of the lubrication system and the application are detected by the electronic control system and are indicated on the display. If an error is displayed, the system is switched OFF until the cause of the error has been eliminated and the error message has been acknowledged.



Error messages are acknowledged and reset by pushing the SELECT button. However, error messages “LC” and “Lo” are automatically acknowledged when errors are corrected (see remedial measures).

7.2 Fault Signaling via the Connected Control System

In case of a malfunction, the connected control system of your equipment merely indicates an unspecified malfunction since the control system only receives a “Low” signal from the lubricator. This means that if your control system indicates a malfunction, you have to use the display of the lubricator to determine the cause of the malfunction (refer to chapter 7.1).

7.3 Trouble Shooting Guide

If there are malfunctions during the operation of the lubrication system, please check for possible causes using the following chart (refer to chart 8).

Every time that an error message is displayed, the red LED is also blinking.

Indication of the display	Error	Possible cause	Remedial measures
<i>E1</i>	Lubricator has been switched off	Excess motor current of the lubricator motor due to a blocked outlet	Clear the blockage and acknowledge the fault by pushing and holding down the SELECT button
<i>E4</i>	Lubricator has been switched off	Drive mechanism is defective	Exchange the drive unit
<i>LC</i>	System does not detect the PRO LC	No PRO LC installed	Install an PRO LC
<i>Lo</i> green LED blinking	Low voltage of back-up battery (lubrication system functions correctly)	Battery PRO B (back-up battery) empty	Insert a new battery PRO B (back-up battery) and use a full PRO LC
No display	System gets no power from the back-up battery	No battery PRO B (back-up battery) inserted	Insert battery PRO B (back-up battery)
In addition to the above, the following malfunctions can occur when a perma distributor PRO MP-6 is connected to the lubrication system:			
<i>E0</i>	Lubrication system has been switched off	Excess motor current of the perma distributor MP-6	Replace perma distributor PRO MP-6
<i>F1 to F6</i>	Error at the displayed lubrication point	Excess motor current of the lubricator motor caused by a blocking of the displayed outlet	Clear the blockage and acknowledge the fault by pushing and holding down the SELECT button
<i>E2</i>	Lubrication system has been switched off	Outlets of distributor not correctly recognized	Replace distributor
<i>E3</i>	Lubrication system has been switched off	Timeout while activating distributor	Replace distributor
		Connection cable damaged	Replace connection cable
<i>E5</i>	Outlet configuration missing	Outlets were not activated	Activate desired outlets (Turn off power supply on PRO C before you acknowledge error messages)

chart 8

8. Disposal



Help us in protecting the environment and saving resources by recycling valuable raw material.
Please follow your local waste disposal regulations.

9. Service

Please contact your local supplier for availability and cost of the following:

- ◆ Returning of the empty lubricator for environmentally safe recycling or disposal

or:

- ◆ exchange of battery PRO B.
- ◆ Exchange of the PRO LC.
- ◆ To pre-set lubricator (LC / lubrication period / outlets).

Translation of the Original Operating Instructions
perma PRO / PRO C LINE 250 / 500



The Expert in Lubrications Solutions



General information

perma PRO / PRO C LINE (+ Distributor PRO MP-6) is based on the function of perma PRO / PRO C.

The general function of perma PRO / PRO C has not been changed.

These perma PRO / PRO C LINE Operating Instructions must always be used together with the Operating Instructions of perma PRO / PRO C / MP-6.

Function Indication on the Display

(see operating instructions perma PRO / PRO C chapter 4.2)



Lubrication system turned off (OFF)



Lubrication system turned on (ON)

Display shows „remaining discharge period“



Differences perma PRO / PRO C LINE (compared to perma PRO / PRO C)

The **pause time** between two discharges and the **discharge amounts** from 1 to 9 strokes can be programmed for each individual outlet.

After each pause time, the system will conduct a discharge with as many strokes as programmed for this outlet.

The following settings and displays are new (operating instructions perma PRO / PRO C chapter 5.8):

- ◆ Number of strokes per discharge (1 stroke = 0.5 cm³)
- ◆ Pause time in days between discharges
- ◆ Display of discharge time remaining

The chart on the following page will assist with settings.



Total discharge period

The maximum grease and battery service life is **24 months** and should not be exceeded. Therefore the longest **total discharge period** of the system is **24 months (or 12 months for perma PRO with LC 500)**. This **total discharge period** calculation is based on the number of outlets selected and the strokes / pause times of each outlet. The total discharge period changes whenever any of these values changes.

Whenever the selected settings would lead to an exceeded total discharge period, the system shows “E9”.

You can either change the settings (1) or you can override “E9” (2).

1. **To change your settings:** Push ON/OFF SELECT or SELECT. The system will return to the configuration menu (without saving the selected settings) and you can change your settings.
2. **To override “E9”** (forces the system to accept settings to exceed the total discharge period): Push MODE / SAVE. The system accepts the exceeded total discharge period (this is also recorded in the internal system memory) and the settings are saved.

NOTE: This setting cannot be changed later.



perma PRO LINE (with battery): perma PRO LINE function must be manually monitored (limited battery capacity!).

New perma PRO C LINE Modes:

Impulse Mode

perma PRO C LINE will work in Impulse Mode if an outlet has been configured with “00” pause time.

After each discharge impulse, the system carries out the preset number of pump strokes per outlet (1 to 9 pump strokes with a 30 second pause time in between each stroke).

This setting can be selected for all active outlets. When power is removed and re-applied the system gives a discharge impulse with predefined amounts to all outlets with “00” pause time. It is **not possible** to display the “discharge time remaining” in Impulse Mode.

Mixed Mode (a combination of Time Mode and Impulse Mode)

A combination of “00” pause time for certain activated outlets and specified pause times for the other remaining outlets will prompt the perma PRO C LINE to carry out discharges with specified discharge amounts and pause times as long as power is applied. If power is removed (for at least 15 seconds) and re-applied, the system gives a discharge impulse with predefined amounts to all outlets with “00” pause time.

It is **not possible** to display the “discharge time remaining” in Mixed Mode.

Settings and Display for perma PRO / PRO C LINE (+ Distributor PRO MP-6)

MODE SAVE	Display	PRO (ON/OFF SELECT) OR (SELECT) PROC	Meaning / Description	
	Ln		Display at delivery with attached PRO LC	
↓ MODE SAVE	Time 08 Weeks LC 500		Display: Discharge time remaining PIN-reset	Info
↓ MODE SAVE	PIN 00	Change first digit ↓ (ON/OFF SELECT) ↓ (SELECT)	Enter first digit of current PIN PIN "00" at delivery	PIN Entry
↓ MODE SAVE	PIN 00	Change second digit ↓ (ON/OFF SELECT) ↓ (SELECT)	Enter second digit of current PIN	
↓ MODE SAVE	Config. LC LC 500	Change from LC500 to LC250 ↓ (ON/OFF SELECT) ↓ (SELECT)	Set PRO LC size	LC
↓ MODE SAVE	Config. Outlets 1 1 <input type="checkbox"/> 4 2 <input type="checkbox"/> 5 3 <input type="checkbox"/> 6	Outlet 1 On / Off ↓ (ON/OFF SELECT) ↓ (SELECT)	Activate outlets: Activate outlet 1 Outlets only displayed if MP-6 is connected	Outlets
	Config. Outlets 1 1 <input checked="" type="checkbox"/> 4 2 <input type="checkbox"/> 5 3 <input type="checkbox"/> 6		Outlet 1 activated	
↓ MODE SAVE	Config. Outlets 2 1 <input type="checkbox"/> 4 2 <input checked="" type="checkbox"/> 5 3 <input type="checkbox"/> 6	Outlet 2 On / Off ↓ (ON/OFF SELECT) ↓ (SELECT)	Outlet 2 activated (if desired, other outlets may be turned On / Off the same way)	Strokes
↓ MODE SAVE	Config. Outlets 41 1 <input type="checkbox"/> 4 2 <input type="checkbox"/> 5 3 <input type="checkbox"/> 6	Changing the number of strokes ↓ (ON/OFF SELECT) ↓ (SELECT)	Enter number of strokes for outlet 1	
↓ MODE SAVE	Config. Time Outlets 20 Days 1 <input type="checkbox"/> 4 2 <input checked="" type="checkbox"/> 5 3 <input type="checkbox"/> 6	Change first digit ↓ (ON/OFF SELECT) ↓ (SELECT)	Pause time configuration for outlet 1: Changing the first digit	Pause time
↓ MODE SAVE ↓ MODE SAVE	Config. Time Outlets 21 Days 1 <input type="checkbox"/> 4 2 <input checked="" type="checkbox"/> 5 3 <input type="checkbox"/> 6	Change second digit ↓ (ON/OFF SELECT) ↓ (SELECT)	Pause time configuration for outlet 1: Changing the second digit	
↓ MODE SAVE	Config. PIN 00	Change first digit ↓ (ON/OFF SELECT) ↓ (SELECT)	PIN (first digit) enter for initial configuration or after a PIN-reset – otherwise, setting is complete	PIN
↓ MODE SAVE	Config. PIN 00	Change second digit ↓ (ON/OFF SELECT) ↓ (SELECT)	PIN (second digit) enter for initial configuration or after a PIN-reset	
↓ MODE SAVE	Ln		Configuration finished	

I N T R O
C O N F I G U R A T I O N M E N U

Repeat for each outlet:
Configuration of strokes and pause time

Total discharge period



A series of 20 horizontal grey lines spaced evenly down the page, providing a template for handwriting practice.

Translation of the Original Operating Instructions
perma Distributor PRO MP-6



The Expert in Lubrications Solutions



The perma Distributor PRO MP-6

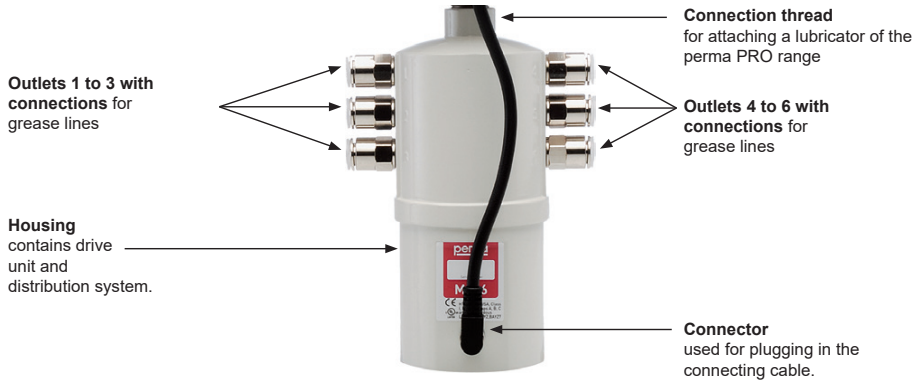

Accessories

Plug (4 pcs.)

for sealing the outlets that are not used.

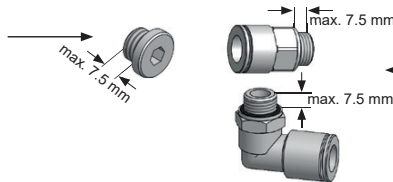

6 connections (straight or angle) for grease lines

Connecting cable (1 pc.)

used for power supply and for communication.



Activation of Outlets on Lubrication System PRO / PRO C

Activation/selection of outlets is done on the connected lubrication system PRO/PRO C.

Please observe operating instructions (refer to chapter 5.8) of the attached lubrication system since the following chart does not go into detail.

Outlets must be activated by the user before operation (factory setting = all outlets inactive).

		<p>On/Off Outlet 1</p> <p>PRO or PRO C</p>	<p>Configuration of outlets: Activation of outlet 1</p>
			<p>Outlet 1 active</p>
		<p>On/Off Outlet 2</p> <p>PRO or PRO C</p>	
			<p>Outlet 2 active (if desired, remaining outlets can be turned On/Off the same way)</p>

Quick Reference Guide for the perma Distributor PRO MP-6

On this page you will find some important information for quick and easy operation and setting of your perma MP-6 distributor. Before the perma MP-6 is used, prior to the assembly of the distributor with a lubricator of the perma PRO range and whenever you need detailed information, you should read the complete Operating Instructions, which contain information that must be observed. Make sure to follow the instructions given in the chapter "Safety Instructions". Additionally, you have to observe the Operating Instructions of the connected lubricator.

1 Assembly of perma Distributor PRO MP-6 (refer to chapter 3.1 and 3.2)

- ◆ Screw connections into the outlets that you want to activate and seal the other outlets with plugs.

2 Connect perma Distributor PRO MP-6 to the Lubricator (refer to chapter 3.3)

- ◆ Screw the lubricator tightly into the thread of the distributor.
- ◆ Position the rear sides of the lubricator and the distributor at one level.
- ◆ Attach the distributor and the lubricator to the mounting device and fix it using the four bores (refer to figure 6).
- ◆ Connect the lubricant tubes ($\varnothing 8 \times 1.5$, inner- $\varnothing 5$ mm, admissible total length per pipe up to 5 m) to the connecting pieces of the distributor and lay them between the distributor and the lubrication point.
- ◆ Connect the lubricator with the distributor using the connecting cable. For this, the lubrication system must be switched off.

3 Determine Discharge Period (refer to chapter 4.7)

- ◆ Determine the required lubricant volume (cm^3) per one hundred operating hours while taking into account the number of open outlets. For this, you have to multiply the lubricant volume with the number of open outlets.
- ◆ You have to take into account that this distributor is able to supply an equal amount of lubricant to up to six lubrication points.
- ◆ Determine the required discharge volume using the Operating Instructions of the lubricator. Depending on the size of the PRO LC you can then determine the setting of the discharge period and the setting mode.

4 Setting and Starting the Complete Lubrication System (refer to chapter 4.5)

- ◆ Set discharge period or impulse mode, size of PRO LC, outlets, PIN (refer to PRO/PRO C operating instructions, chapter 5.8, of each lubricator).
- ◆ Keep the ON/OFF/SELECT button of the lubricator **PRO** pressed until the display no longer shows "--" (for Off).
To start the lubrication system **PRO C** switch on power supply.
- ◆ An automatic initialization is carried out by the lubrication system and the display shows the counting of the outlets.
- ◆ After the initialization is complete, the display of the lubricator shows the remaining volume and the lubrication system starts to operate.

1. General Information

1.1 Delivery / Content

- ◆ The perma MP-6 is a distributor for the lubricators of the perma PRO range. The distributor is equipped with all necessary components and accessories and can be set and fitted according to customer requirements.
- ◆ Six optional connections (G1/8 straight or G1/8 90° for tubes Ø 8 x 1.5)
- ◆ Four plugs
- ◆ Screws for mounting the distributor
- ◆ Operating Instructions and EC Conformity Declaration
- ◆ Upon delivery, make sure to check if the delivered goods correspond to your order. perma-tec GmbH & Co. KG will not accept liability for subsequent claims of any shortcomings.
- ◆ Please immediately forward any claims:
 - of noticeable transport damage directly to the forwarder.
 - of noticeable faults, shortcomings or defects directly to your local supplier.

1.2 Markings

- ◆ The perma MP-6 distributor is clearly marked with a serial number and a label on the drive unit.
- ◆ **CE mark** on the drive unit
- ◆ **UL mark** on the drive unit:
 "This equipment is suitable for use in Class I, Div. 2, Groups A, B, C and D; or Non-Hazardous Locations only. Warning - Explosions Hazard - Substitution of components may impair suitability for Class I, Division 2." The lubricants dispensed by this equipment are to have flash points greater than 200 °F."
- ◆ **EAC mark** on packaging
- ◆ Manufacturer:
 perma-tec GmbH & Co. KG
 Hammelburger Straße 21
 97717 Euerdorf
 Germany
 Tel: +49 (0) 9704 609-0 E-mail: info@perma-tec.com
 Fax: +49 (0) 9704 609-50 Web page: www.perma-tec.com

1.3 Intended Usage

The distributor perma MP-6

- ◆ may only be used together with a lubricator of the perma PRO range;
- ◆ must be connected to the lubricator using the connecting cable;
- ◆ immediately supplies up to **six** lubrication points with lubricant, at a **pressure build-up of max. 25 bar (360 psi)**, constantly, precisely and independent of temperature;
- ◆ has passed the environmental audit according to standard EN 60068-2-6 (vibration test) without any component damage or malfunctions. In test: PRO drive unit with MP-6, PRO LC 500 cm³, and mounting device in various mounting positions;
- ◆ can be used for all lubrication points of sliding- and roller bearings, drive- and transport chains, sliding guide ways, open gears and seals;
- ◆ **must** be used with a suitable protection box (refer to "Accessories and Spare Parts") if operated outside or around splashing water;
- ◆ may only be used at lubrication points of the same type, which require identical discharge volumes;
- ◆ may only be fitted with original connections and plugs from perma-tec;
- ◆ may only be used with original grease lines from perma-tec;
- ◆ is intended for use on machinery and equipment;
- ◆ is only to be used for the intended purpose and purposes confirmed by perma-tec;
- ◆ is only to be used for operating conditions recommended in this operating manual;
- ◆ is only to be used with settings and variations recommended in this operating manual.

Any other usage, setting, addition, and variation is considered to be inappropriate!

2. Technical Data

	perma Distributor PRO MP-6
Length	148 mm
Diameter	64 mm
Weight	ca. 0.960 kg
Number of outlets	2 minimum 6 maximum
Maximum working pressure	25 bar (360 psi)
Lubricants	Greases up to rated consistency NLGI 2
Ambient temperature	-20 °C to +60 °C / -4 °F to +140 °F
Power supply	from the lubricator via connecting cable
Emission sound pressure level	< 70 dB(A)
Connection thread for lubricators of the PRO range	G3/8 inside
Connection thread for grease line	G1/8 inside
Diameter of grease line	8 x 1.5 (inner-Ø 5 mm)
Length of the grease line	admissible total length per pipe up to 5 m; for details please regard operating manual PRO/PRO C chapter 2, chart 1
Storage conditions	Dry, dust-free at temperatures of +20 °C ± 5 °C / 68 °F ± 9 °F
Protection class	IP 54

chart 1

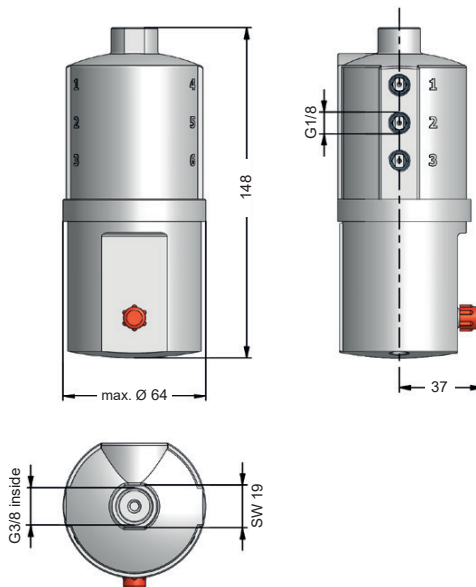

figure 1

2.1 Design of the perma Distributor PRO MP-6

Each distributor (refer to figure 2) is supplied with all necessary accessories (refer to figure 3). The user has to install the required connections or plugs and must connect the distributor to a lubricator of the perma PRO range. The perma MP-6 distributor consists of:

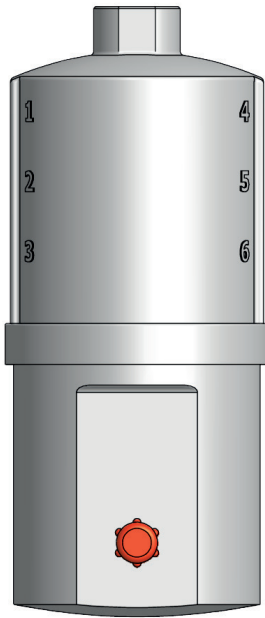

figure 2

← Housing containing the drive unit and the distribution system (max. 6 outlets).

2.2 Accessories



← Connections (6 pcs.) for grease lines

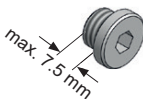

← Plugs (4 pcs.) for sealing the outlets which are not used.



← Connecting cable (short) for power supply of the distributor and for communication between distributor and lubricator

figure 3

3. Mounting and Assembly of the Distributor

3.1 Mounting the Connections

- ◆ Chose the number (6 max.) and the position of the outlets that you intend to use.
- ◆ Screw the connections tightly (max. torque of 2 Nm) into the outlets to be opened (refer to figure 4).
- ◆ Seal all the remaining outlets using the enclosed plugs.



figure 4

3.2 Distributor Housing



Never loosen these screws at the bottom of the distributor and **never open** the housing.

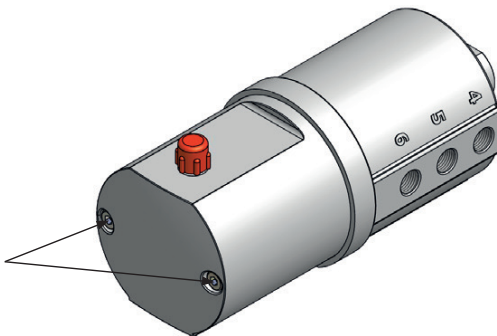

figure 5

3.3 Combination of Distributor and Lubricator

After you have equipped the perma MP-6 with connections, you can connect the distributor to a lubricator of the PRO range.



Screw the distributor and the lubricator together. Attach both to the perma mounting device and install the mounting device.

Direct Mounting of the Distributor onto the Lubricator

- ◆ Before you connect the distributor and the lubricator, all lubrication points must be pre-greased and all grease lines must be pre-filled with the same lubricant that the PRO LC contains. For that, perma-tec offers a 400 g lubrication cartridge for manually-operated grease presses with the requested lubricant.
- ◆ Screw the lubricator tightly into the G3/8 thread of the distributor.
- ◆ Position the rear sides of the lubricator and the distributor at one level.
- ◆ Attach the supplied mounting device to the distributor and the lubricator using the enclosed hex head bolts (M6 x 16) and the washers.
- ◆ Screw the mounting device together with the lubrication system onto a support of your system. For the position of the bores of the four fixing screws refer to figure 6 below. You have to use four hexagon screws M6 x 25 (e.g. on metal ground).
- ◆ Connect the grease lines to the connections of the distributor and install the tubes correctly between the distributor and the lubrication point. Tube length may not exceed five meters per outlet.
- ◆ Attach the required connections to the ends of the lubricant tubes.
- ◆ While the lubrication system is **switched off** connect the lubricator to the distributor with the connecting cable.
- ◆ The lubrication system is now ready for operation.



Ensure correct and tight assembly of the connections and grease lines to avoid possible leakage.

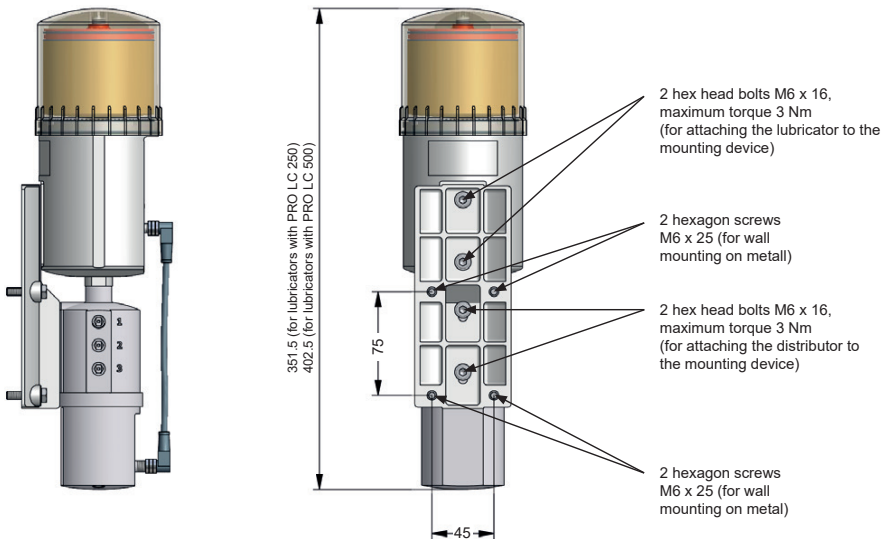

figure 6

Separate Mounting of Distributor and Lubricator

Separate mounting of the distributor and the lubricator is possible.

For this, perma-tec offers an additional mounting device, the necessary tube connections and a longer connecting cable (refer to "Accessories and Spare Parts").

Attach the lubricator of the PRO range to your system as described in its Operating Instructions and mount the distributor as follows:

- ◆ Attach the mounting device to the distributor using the enclosed hex head bolts (M6 x 16) and the washers.
- ◆ Screw the mounting device with the distributor onto a support of your system.
For the bore position of the four fixing screws refer to figure 7 below. At least four hexagon screws M6 x 25 must be used (e.g. on metal ground).
- ◆ Before you connect the outlets of the distributor to any grease lines and hoses you have to pre-lubricate all lubrication points and pre-fill all grease lines with the same lubricant that is contained in the PRO LC of the lubricator. For that, perma-tec offers a 400 g lubrication cartridge for manually-operated grease presses with the requested lubricant.
- ◆ Fit the reducer coupling G3/8 female to G1/8 female for tube oØ 8 mm (nickel-plated) Art. No. 101545 and the tube connector G1/8 male for tube oØ 8 mm straight (brass nickel-plated) Art. No. 101570 on the lubricator.
- ◆ Fit the tube connector G3/8 male for tube oØ 8 mm straight (brass nickel-plated) Art. No. 101498 on the distributor.
- ◆ Connect the distributor to the PRO lubricator with the grease line. Maximum tube length 2 meters (Ø 8 x 1.5, inner-Ø 5 mm).
- ◆ Connect the grease lines to the connections of the distributor and install them correctly between the distributor and the lubrication point. **The grease line between lubricator, distributor and lubrication point must not exceed a total length of 5 meters (for details about temperature and lubricant please refer to operating instructions of PRO/PRO C chapter 2, chart 1).**
- ◆ Fit the ends of the grease lines with the required tube connections.
- ◆ While the lubrication system is **switched off**, connect the lubricator to the distributor with the connecting cable (long).
- ◆ The lubrication system is now ready for operation.



Ensure correct and tight assembly of the connections and grease lines to avoid possible leakage.

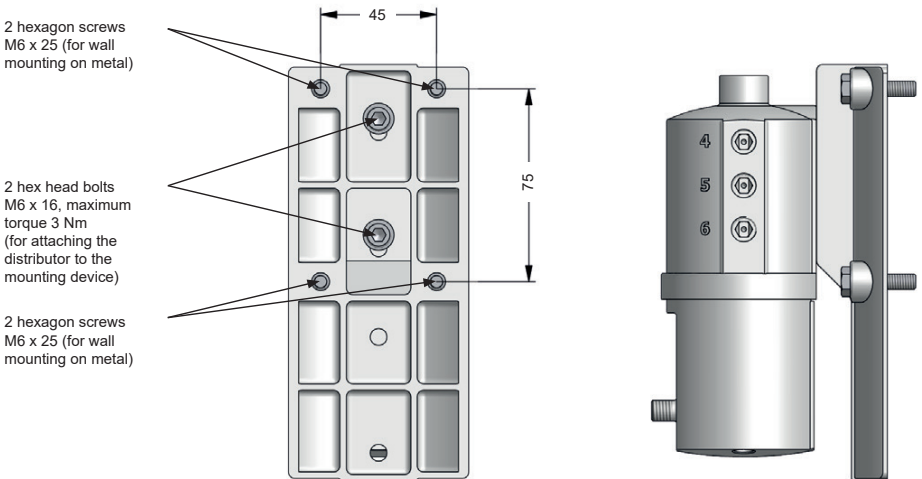

figure 7

4. Operation and Control

Please note that the perma MP-6 distributor may only be connected to a lubricator of the PRO range. If you combine the distributor with a PRO lubricator, you also have to observe the Operating Instructions of the lubricator.

4.1 Preparations

- ◆ Prior to installing the lubrication system (lubricator and distributor), all lubrication points must be pre-lubricated and all grease lines must be sufficiently pre-filled with the same lubricant that is contained in the PRO LC of the lubricator. For this, perma-tec offers a 400 g lubrication cartridge for grease presses with the corresponding lubricant (refer to "Accessories and Spare Parts").
- ◆ A complete filling of the MP-6 and tube connections can be achieved by activating the automatic prefilling INIT FILL (refer to chapter 4.11).
- ◆ When installing the lubrication system, the supplied perma-tec mounting device should be used. The lubricator and the distributor should be fixed to this mounting device (refer to chapter 3.3).
- ◆ The grease lines must be installed and mounted correctly. Grease lines must be from perma-tec and cannot exceed a length of 5 meters per outlet.



During initial operation, the drive of the PRO series is filled with perma Food grade grease H1 SF 10. When using the distributor PRO MP-6, please activate the function INIT FILL (prefill / refer to chapter 4.11) in order to exchange the lubricant. Please press "additional discharge" repeatedly until the lubricant is discharged at the PRO MP-6 distributor outlet (refer to the PRO / PRO C operating instructions chapter 5.8).

4.2 Prior to Operation

- ◆ Check all parts of the distributor and the complete lubrication system for obvious damages!
- ◆ Did you correctly assemble, mount, and tighten all of the connections and the plugs of the distributor?
- ◆ Are the grease lines, coming from the distributor, mounted correctly on the connections?
- ◆ Was the drive unit of the lubricator set to the discharge period requested by the operator while taking into account the required discharge volume and the number of open outlets?
- ◆ Did you correctly assemble, mount and tighten all of the parts?

4.3 Setting into Operation

- ◆ Open the required number of outlets by mounting the connections and seal the unused outlets with plugs (refer to chapter 3.1).
- ◆ Screw together the distributor and the lubricator (refer to chapter 3.3).
- ◆ If required, mount the distributor together with the lubricator onto the mounting device and onto a fixing device for wall-mounting (refer to chapter 3.3).
- ◆ Connect the distributor to the lubricator with the connecting cable to enable signal exchange (refer to chapter 3.3).
- ◆ Determine the discharge period for the open outlets (refer to chapter 4.7).
- ◆ Set the discharge period with the push buttons on the lubricator (refer to chapter 4.8).
- ◆ Select the desired active outlets (refer to chapter 4.9) and - if desired - the prefilling INIT FILL (refer to chapter 4.11) with the push buttons on the lubricator.
- ◆ If necessary, do a manual initialization after a distributor exchange (refer to chapter 4.10).
- ◆ Did the lubricator correctly recognize the distributor during initialization?
- ◆ Carry out an additional discharge (refer to chapter 4.8).
If the drive motor has started and the green LED is lit, the lubricator has started to discharge. The display of the lubricator indicates the remaining volume (% Vol.) of the PRO LC.



The operator must always check the customer-specific settings and if necessary change them before the lubricator is set into operation! In addition, the Operating Instructions of the lubricator must be observed.

4.4 During Operation

- ◆ Carry out regular inspections during operation. You should pay special attention to leakage, to the condition of the distributor, and the complete lubrication system!
- ◆ Regularly check the condition of the grease lines and the connections!
- ◆ Regularly check the filling level of the transparent PRO LC of the lubricator!
- ◆ After one or several additional discharges, you have to calculate the remaining discharge period and mark it in your lubrication and maintenance schedule.
- ◆ If a malfunction is indicated on the display, you can determine the cause using the trouble shooting guide (refer to chart 3, chapter 5.2). If the fault cannot be fixed, please contact your supplier for technical support.



Additional discharges and long machine standstills must always be taken into account with regard to the remaining discharge period of the lubrication system.

4.5 Switching the Complete Lubrication System On

To switch on the lubrication system **PRO** (refer to figure 8), keep the ON/OFF/SELECT button of the lubricator pressed until the display no longer shows "--".

To start the lubrication system **PRO C** you have to switch on power supply.

After switch-on, the lubricator automatically does an initialization (system recognizes the activated outlets). During initialization, the outlets (represented by squares) in the display are blinking. Activated outlets (squares) will be blackened, inactive outlets (squares) are blank. When the initialization process is finished, the green LED blinks and the display shows the outlets (squares), the remaining volume (in percent), and the PRO LC size (250 and 500 cm³).

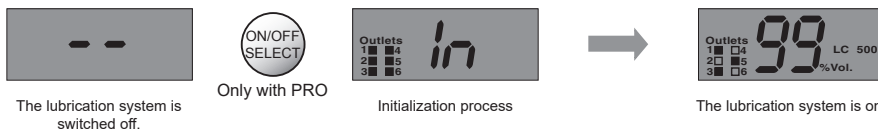

figure 8



When the lubrication system is switched on for the first time, the initialization is carried out automatically by the lubricator. The outlets (squares), the remaining volume (in percent), and the PRO LC size (250 or 500 cm³) are only displayed after the initialization process is finished.

4.6 Switching the Complete Lubrication System Off

To switch off the lubrication system **PRO** (refer to figure 9), keep the ON/OFF/SELECT button of the lubricator pressed until the display no longer indicates the remaining volume but indicates "--" instead.

To stop the lubrication system **PRO C** you only have to switch off power supply.

When the lubrication system is switched off, all of the settings are saved. This means that if you start the lubricator again, it will take up operation at the point where it had been switched off.



figure 9

4.7 Determining the Discharge Period



The required discharge period must be determined using the Operating Instructions of the connected lubricator. You have to take into account that the distributor perma MP-6 is able to supply an equal amount of lubricant to up six lubrication points.

When determining the discharge volume, you have to multiply the number of open outlets with the required discharge volume per outlet. With the result of this calculation you can determine the setting point of the discharge period using the Operating Instructions of the connected lubricator.

4.8 Setting the Discharge Period

The discharge period can be set any time via the lubricator and without having to interrupt the operation. It does not matter if the lubrication system is switched on or off, since the system switches back to its original operating status after the changes have been made.

For a precise setting of the discharge period, please refer to the Operating Instructions of the connected lubricator.

Additional Discharge

With an additional discharge, all open lubrication points can be supplied with an additional amount of the lubricant. Each open outlet provides 1.0 cm³ of the lubricant.

For an additional discharge, the lubrication system must be **switched on** and you have to press and hold down both buttons of the lubricator simultaneously (refer to figure 10).

An additional discharge is carried out at each activated outlet (it takes approx. 30 seconds between outlets).

This means that if all outlets are open, the process of an additional discharge takes maximum 14 minutes.



figure 10

For an additional discharge, press both buttons of the lubricator and hold them down.

An additional discharge is only possible at temperatures **above 0 °C (32 °F)**.

Every additional discharge reduces the remaining discharge period since an increased amount of the lubricant has been supplied. This must be taken into account in your lubrication and maintenance schedule.



The time between two additional discharges is at least 30 seconds. Each additional long push of both buttons (figure 10) will be recorded by the system and leads to further additional discharges on all outlets. The system records up to 5 additional discharges.

Calculation of the Remaining Discharge Period



Please note, that in case of one or several additional discharges, the remaining discharge period of the lubrication system must be recalculated. This also applies in case of a shut-off of the lubrication system due to an extended machine standstill (e.g. weekends or annual holidays).

For information on the calculation of the remaining discharge period, please refer to the Operating Instructions of the connected lubricator.

You should also note the result of your calculation of the remaining discharge period in your lubrication and maintenance schedule.

4.9 Activation of Outlets



Chart 2 below only includes part of the complete Operating Instructions. Therefore please also refer to the Operating Instructions (refer to chapter 5.8) of your lubricator.

All outlets must be activated by the user before operation (factory setting = all outlets inactive). The lubricator must be turned off before carrying out initialization.

Chart 2 shows an example for the configuration of outlets: **Outlets**

All outlets are inactive (factory setting). You want to activate outlets 1, 3, 5.

Outlets 2, 4, and 6 should be inactive (closed).

	Display	PRO or PROC	Meaning/Description	Outlets
		Activation Outlet 1 	Outlet configuration: Activation of outlet 1 Outlets are only displayed if MP-6 is connected	
			Outlet 1 active	
			Outlet 2 inactive	
		Activation Outlet 3 	Activation of outlet 3	
			Outlet 3 active Outlet 4 inactive	
		Activation Outlet 5 	Activation of outlet 5	
			Outlet 5 active Outlet 6 inactive	
			Outlet configuration finished	

chart 2

Caption:

Function	Short push	Long push	Blinking in Display
Symbol			

4.10 Initialization of Distributor

Automatic Initialization of the Distributor

In order to supply lubricant to all open outlets and to ensure a correct operation of the perma MP-6, an automatic initialization of the lubrication system is carried out when the system is switched on for the first time. During initialization the system recognizes the activated outlets. Outlets (represented by squares) in the display are blinking. Activated outlets (squares) will be blackened, inactive outlets (squares) are blank.



When initialization is finished, the display shows the remaining volume and activated outlets. The green LED starts to blink and the lubrication system operates.

Manual Initialization of the Distributor



If you connect a new distributor to the lubricator (exchange old distributor with new one), you must do a manual initialization of the perma MP-6. The system recognizes the activated outlets. Outlets (represented by squares) in the display are blinking. Activated outlets (squares) will be blackened, inactive outlets (squares) are blank.

A manual initialization (long push of both buttons on the lubricator – refer to figure 11) can only be done when the lubrication system is **turned OFF** (display of lubricator shows "--" for OFF).

PRO will immediately start initialization (refer to figure 12).

PRO C will show a blinking "In" in the display for the triggered initialization – the actual initialization will be carried out as soon as the system is turned ON (refer to figure 12).



figure 11 For a manual initialization, press and hold down both buttons of the lubricator simultaneously.



Lubricator PRO

When the manual initialization is completed, the display of the lubricator PRO shows "--" for OFF and the lubrication system is switched off.



Lubricator PRO C

When the manual initialization is completed, the display of the lubricator PRO C shows the remaining volume of the PRO LC and the lubrication system is switched on.

Initialization Sequence

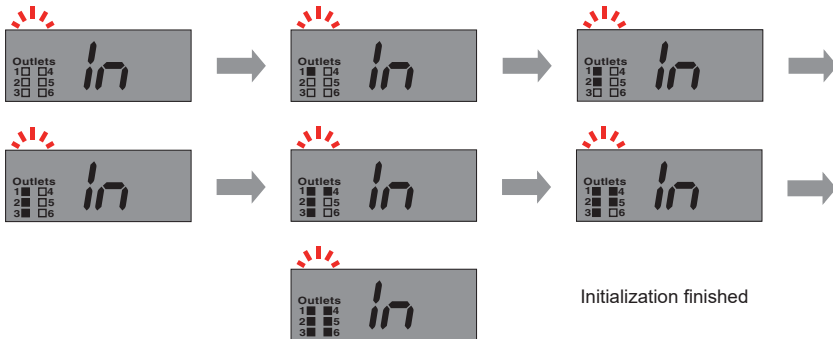

figure 12

4.11 Activation of Prefilling INIT FILL

Function IF (= INIT FILL) enables you to start the automatic prefilling of the distributor MP-6 and existing tube connections.



Prefilled grease lines must only be connected to the distributor until after the distributor has been prefilled.

Activation of the prefilling process can be done any time **during outlet configuration** by pushing down and holding both buttons on the lubricator at the same time for more than 4 seconds (see figure 13).



figure 13 Push down both buttons of the lubricator at the same time > 4 s.

The display will show "IF" for one second to confirm the successful IF-activation. Activation of INIT FILL can take place at any time during outlet configuration.



figure 14 Display example of „IF“ confirmation (1 s)

Starting the Process of Prefilling INIT FILL

Prefilling INIT FILL of the distributor MP-6 will start when **perma PRO MP-6** is turned on or for **perma PRO C MP-6** when power is applied.

The display will show "IF" and the outlets (active outlets = black box / outlet which is being filled will blink). All active outlets will get prefilled.



figure 15 Display example during prefilling (outlet 3 blinking)

Sequence of Prefilling INIT FILL

The picture on the right shows the prefilling sequence 3/6/2/5/1/4.

The first activated outlet will be filled with 11 pump strokes. This fills the outlet and the free space inside the MP-6.

Each of the following activated outlets will receive 4 pump strokes until all activated outlets have been prefilled.

The process takes about 4.5 minutes for 6 active outlets (+ 1 minute "h" initialisation run of the distributor MP-6 during first time operation).

If additional connecting parts are installed, they can be prefilled with special discharges after the INIT FILL process.

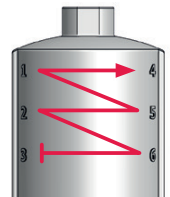

figure 16 Prefilling sequence 3/6/2/5/1/4

5. Trouble Shooting

5.1 Error Messages of the Distributor on the Display of the Lubricator

Possible errors of the distributor and the complete lubrication system are detected by the electronic control unit and are indicated on the display of the lubricator. For example, if the error message F_2 is shown on the display, the required pressure at the second connected lubrication point exceeds 25 bar (360psi). This means that this lubrication point is no longer supplied with lubricant. The distributor still provides lubricant to all other activated lubrication points. Correct the malfunction of the second lubrication point (e.g. grease line bent or blocked) and acknowledge it by pushing the ON/OFF/SELECT button on the lubricator PRO or the SELECT button on lubricator PRO C.



Error messages are acknowledged and reset by pushing the ON/OFF/SELECT or SELECT button. However, error messages “ LC ” and “ L_0 ” are automatically acknowledged when errors are corrected (see remedial measures).

5.2 Trouble Shooting Guide

If there are malfunctions during the operation of the distributor or the lubrication system, please check for possible causes using the following chart (refer to chart 3). If you have to deal with a malfunction that is not listed in the chart below, please contact your local supplier for technical support.

Every time that an error message is shown on the display of the lubricator, the red LED at the lubricator is also blinking.

Indication of the display	Error	Possible cause	Remedial measures
$E0$	Lubrication system has been switched off	Excess motor current of the perma distributor MP-6	Replace perma distributor PRO MP-6
F_1 to F_6	Error at the displayed lubrication point	Excess motor current of the lubricator motor caused by a blocking of the displayed outlet	Clear the blockage and acknowledge the fault by pushing and holding down the ON/OFF/SELECT or SELECT button
$E2$	Lubrication system has been switched off	Outlets of distributor not correctly recognized	Replace distributor
$E3$	Lubrication system has been switched off	Timeout while activating distributor Connection cable damaged	Replace distributor Replace connection cable
$E4$	Lubrication system has been switched off	Drive mechanism of the lubricator is defective	Replace the drive unit of the lubricator
$E5$	Outlet configuration missing	Outlets were not activated	Activate desired outlets (Turn off power supply on PRO C before you acknowledge error messages)
LC	Lubrication system does not detect the PRO LC	No PRO LC installed	Install an PRO LC
L_0 (for PRO)	No power supplied to the system from the battery	No battery PRO B inserted or battery PRO B empty	Insert a new battery PRO B and use a full PRO LC
L_0 (for PRO C) green LED blinking	Low voltage of back-up battery (lubrication system functions correctly)	Battery PRO B (back-up battery) empty	Insert a new battery PRO B (back-up battery) and use a full PRO LC
No display (for PRO)	System gets no power from internal back-up battery	Internal back-up battery empty	Replace the drive unit of the lubricator
No display (for PRO C)	System gets no power from the back-up battery	No battery PRO B (back-up battery) inserted	Insert battery PRO B (back-up battery)

chart 3

6. Disposal



Help us in protecting the environment and saving resources by recycling valuable raw material.
Please follow the individual waste disposal regulations in your country.

7. Service







If you wish to return a perma MP-6 that is no longer used, please check with your local supplier for possible return to recycle or dispose of the used parts in an environmentally safe manner.



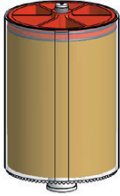

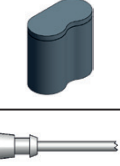
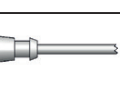



Due to the high pressure of up to 25 bar (360 psi), you should only use **genuine** spare parts and accessories from perma-tec in order to ensure a reliable operation of the distributor and the complete lubrication system. This especially applies to connections and lubricant tubes.

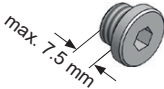
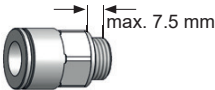
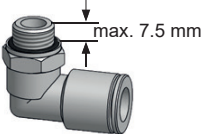

Spare parts and accessories must meet the technical requirements!
This is always guaranteed with genuine spare parts and accessories from perma-tec.

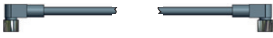
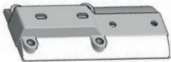
Spare parts	Art. No.	Illustration
perma PRO LC 250 filled with lubricant	on request	
perma PRO LC 500 filled with lubricant	on request	
Cover for PRO LC 250 made of transparent plastic	106959	
Cover for PRO LC 250 made of aluminium for applications with ester-containing lubricants	106961	
Cover for PRO LC 500 made of transparent plastic	106960	
Cover for PRO LC 500 made of aluminium for applications with ester-containing lubricants	106962	
Battery PRO B	106953	
Cable PRO C M12 5 m	106942	
Cable PRO C M12 10 m	106943	

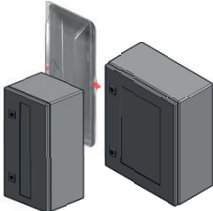
Spare parts	Art. No.	Illustration
Distributor PRO MP-6	106939	
Plug	103288	
Tube connector G1/8 male for tube oØ 8 mm straight (brass nickel-plated)	101570	
Tube connector G1/8 male for tube oØ 8 mm 90° - rotary type (brass nickel-plated)	101571	
Reducer coupling G3/8 female to G1/8 female for tube oØ 8 mm (nickel-plated)	101545	
Tube connector G3/8 male for tube oØ 8 mm straight (brass nickel-plated)	101498	
Connecting cable PRO MP-6 14 cm	106940	
Connecting cable PRO MP-6 2 m	106941	
Mounting device PRO (for wall mounting)	101568	
400 g Cartridge filled with lubricant (to be used for pre-filling grease lines with a grease gun)	on request	
Tube up to +100 °C oØ 8 mm x iØ 5 mm (PA) - for PRO with different lengths	101569	
Protection box single (steel) Protection box single (plastic) Protection box double (steel)	101527 101548 111153	







Declaration of Conformity



PRO / PRO LINE

CE

UK
CA

 EG/EU-Konformitäts- erklärung nach Richtlinie 2006/42/EG und Richtlinie 2014/30/EU	 Déclaration CE/UE de conformité selon la directive 2006/42/CE et directive 2014/30/UE	 Declaración CE/UE de conformidad según la directiva 2006/42/CE y directiva 2014/30/UE	 Dichiarazione di conformità CE/UE secondo la direttiva 2006/42/CE e direttiva 2014/30/UE	 EC/EU Declaration of Conformity according to Directive 2006/42/EC and Directive 2014/30/EU	 UKCA Declaration of Conformity according to Supply of Machinery (Safety) Regulations 2008 and Electromagnetic Compatibility Regulations 2016
perma-tec GmbH & Co. KG Hammelburger Straße 21 97717 Euerdorf GERMANY					
Der Hersteller erklärt hiermit, dass das bezeichnete Produkt in den gelieferten Ausführungen den Bestimmungen der oben gekennzeichneten Richtlinien - einschließlich derer zum Zeitpunkt der Erklärung geltenden Änderungen - entspricht.	Le fabricant déclare par la présente que le produit désigné dans sa version livrée est conforme aux dispositions des directives citées ci-dessus - ainsi qu'aux modifications en vigueur au moment de la certification.	Por la presente el fabricante declara, que todas las versiones disponibles de este producto se ajustan a las directivas arriba indicadas, incluyendo los cambios que se produzcan al tiempo de emitir esta declaración.	Il produttore con la presente dichiara che il prodotto designato nei modelli consegnati è conforme alle disposizioni delle norme sopra riportate, incluse le variazioni valide al momento della dichiarazione.	The manufacturer hereby declares that the product as described in the given statement conforms to the regulations appertaining to the directives referred to above, including any amendments thereto which are in force at the time of the declaration.	
In der Gemeinschaft ansässige Person, die bevollmächtigt ist, die relevanten technischen Unterlagen zusammenzustellen:	Personne établie dans la Communauté autorisée à établir le dossier technique pertinent:	Persona con residencia en la Comunidad que está autorizada a crear los pertinentes documentos técnicos:	Persona residente nella Comunità autorizzata a raccogliere la documentazione tecnica necessaria:	Person residing within the Community authorised to compile the relevant technical documentation:	UK authorized representative:
perma-tec GmbH & Co. KG Hammelburger Straße 21 97717 Euerdorf GERMANY					Daniel Gogola 25 Barnfield, East Allington, Totnes DEVON TQ9 7QR UNITED KINGDOM
Produktbezeichnung:	Désignation:	Tipo de producto:	Descrizione del prodotto:	Product description:	
Automatisches Schmiersystem	Système de lubrification automatique	Sistema de lubricación automático	Sistema di lubrificazione automatica	Automatic lubrication system	
Produktname:	Nom du produit:	Denominación producto:	Nome del prodotto:	Product name:	
PRO / PRO LINE					
Typ:	Type:	Tipo:	Tipo:	Type:	
PRO 250 / 500			PRO LINE 250 / 500		
Folgende harmonisierte Normen wurden angewandt:	Les normes associées suivantes ont été utilisées:	Se han aplicado las siguientes normas de armonización:	Sono state recepite le seguenti norme di standardizzazione:	The following harmonised / designated standards were applied:	
EN ISO 12100:2010 EN IEC 61000-6-2:2019, EN IEC 61000-6-4:2019					

Euerdorf, 27 March 2023

Dr. Abassin Aryobsei, CEO

Dr. Matthias Lenhart, Technical Director

PRO C / PRO C LINE



EG/EU-Konformitäts- erklärung nach Richtlinie 2006/42/EG und Richtlinie 2014/30/EU	Déclaration CE/UE de conformité selon la directive 2006/42/CE et directive 2014/30/UE	Declaración CE/UE de conformidad según la directiva 2006/42/CE y directiva 2014/30/UE	Dichiarazione di conformità CE/UE secondo la direttiva 2006/42/CE e direttiva 2014/30/UE	EC/EU Declaration of Conformity according to Directive 2006/42/EC and Directive 2014/30/EU	UKCA Declaration of Conformity according to Supply of Machinery (Safety) Regulations 2008 and Electromagnetic Compatibility Regulations 2016
perma-tec GmbH & Co. KG Hammelburger Straße 21 97717 Euerdorf GERMANY					
Der Hersteller erklärt hiermit, dass das bezeichnete Pro- dukt in den gelieferten Ausführungen den Bestimmungen der oben gekennzeichneten Richtlinien - einschließlich derer zum Zeitpunkt der Erklärung geltenden Änderungen - entspricht.	Le fabricant déclare par la présente que le produit désigné dans sa version livrée est conforme aux dispositions des direc- tives citées ci-dessus - ainsi qu'aux modifications en vigueur au moment de la certification.	Por la presente el fabricante declara, que todas las versiones disponibles de este producto se ajustan a las directivas arriba indicadas, incluyendo los cambios que se produzcan al tiempo de emitir esta declaración.	Il produttore con la presente dichiara che il prodotto de- signato nei modelli consegnati è conforme alle disposizioni delle norme sopra riportate, incluse le variazioni valide al momento della dichia- razione.	The manufacturer hereby declares that the product as described in the given statement conforms to the regulations appertaining to the directives referred to above, including any amendments thereto which are in force at the time of the declaration.	
In der Gemeinschaft ansässige Person, die bevollmächtigt ist, die relevanten techni- schen Unterlagen zusammenzustellen:	Personne établie dans la Communauté autorisée à établir le dossier technique pertinent:	Persona con residencia en la Comunidad que está autorizada a crear los pertinentes documentos técnicos:	Persona residente nella Comunità autorizzata a racogliere la documentazione tecnica necessaria:	Person residing within the Community authorised to compile the relevant technical documentation:	UK authorized representative:
perma-tec GmbH & Co. KG Hammelburger Straße 21 97717 Euerdorf GERMANY					Daniel Gogola 25 Barnfield, East Allington, Totnes DEVON TQ9 7QR UNITED KINGDOM
Produktbezeichnung:	Désignation:	Tipo de producto:	Descrizione del pro- dotto:	Product description:	
Automatisches Schmiersystem	Système de lubrification automatique	Sistema de lubricación automático	Sistema di lubrificazione automatica	Automatic lubrication system	
Produktname:	Nom du produit:	Denominación pro- ducto:	Nome del prodotto:	Product name:	
PRO C / PRO C LINE					
Typ:	Type:	Tipo:	Tipo:	Type:	
PRO C 250 / 500			PRO C LINE 250 / 500		
Folgende harmoni- sierte Normen wurden angewandt:	Les normes associées suivantes ont été utilisées:	Se han aplicado las siguientes normas de armonización:	Sono state recepite le seguenti norme di standardizzazione:	The following harmonised / designated standards were applied:	
EN ISO 12100:2010 EN IEC 61000-6-2:2019, EN IEC 61000-6-4:2019					







Euerdorf, 27 March 2023

Dr. Abassin Aryobsei, CEO

Dr. Matthias Lenhart, Technical Director

PRO MP-6 Distributor



					
EG/EU-Konformitäts- erklärung nach Richtlinie 2006/42/EG und Richtlinie 2014/30/EU	Déclaration CE/UE de conformité selon la directive 2006/42/CE et directive 2014/30/UE	Declaración CE/UE de conformidad según la directiva 2006/42/CE y directiva 2014/30/UE	Dichiarazione di conformità CE/UE secondo la direttiva 2006/42/CE e direttiva 2014/30/UE	EC/EU Declaration of Conformity according to Directive 2006/42/EC and Directive 2014/30/EU	UKCA Declaration of Conformity according to Supply of Machinery (Safety) Regulations 2008 and Electromagnetic Compatibility Regulations 2016
perma-tec GmbH & Co. KG Hammelburger Straße 21 97717 Euerdorf GERMANY					
Der Hersteller erklärt hiermit, dass das bezeichnete Pro- dukt in den gelieferten Ausführungen den Bestimmungen der oben gekennzeichneten Richtlinien - einschließlich derer zum Zeitpunkt der Erklärung geltenden Änderungen - entspricht.	Le fabricant déclare par la présente que le produit désigné dans sa version livrée est conforme aux dispositions des direc- tives citées ci-dessus - ainsi qu'aux modifications en vigueur au moment de la certification.	Por la presente el fabricante declara, que todas las versiones disponibles de este producto se ajustan a las directivas arriba indicadas, incluyendo los cambios que se produzcan al tiempo de emitir esta declaración.	Il produttore con la presente dichiara che il prodotto de- signato nei modelli consegnati è conforme alle disposizioni delle norme sopra riportate, incluse le variazioni valide al momento della dichia- razione.	The manufacturer hereby declares that the product as described in the given statement conforms to the regulations appertaining to the directives referred to above, including any amendments thereto which are in force at the time of the declaration.	
In der Gemeinschaft ansässige Person, die bevollmächtigt ist, die relevanten techni- schen Unterlagen zusammenzustellen:	Personne établie dans la Communauté autorisée à établir le dossier technique pertinent:	Persona con residencia en la Comunidad que está autorizada a crear los pertinentes documentos técnicos:	Persona residente nella Comunità autorizzata a raccogliere la documentazione tecnica necessaria:	Person residing within the Community authorised to compile the relevant technical documentation:	UK authorized representative:
perma-tec GmbH & Co. KG Hammelburger Straße 21 97717 Euerdorf GERMANY					Daniel Gogola 25 Barnfield, East Allington, Totnes DEVON TQ9 7QR UNITED KINGDOM
Produktbezeichnung:	Désignation:	Tipo de producto:	Descrizione del pro- dotto:	Product description:	
Automatisches Schmier-system	Système de lubrification automatique	Sistema de lubricación automático	Sistema di lubrificazione automatica	Automatic lubrication system	
Produktname:	Nom du produit:	Denominación pro- ducto:	Nome del prodotto:	Product name:	
PRO MP-6 Verteiler	PRO MP-6 Répartiteur	PRO MP-6 Distribuidor	PRO MP-6 Distributore	PRO MP-6 Distributor	
Folgende harmoni- sierte Normen wurden angewandt:	Les normes associées suivantes ont été utilisées:	Se han aplicado las siguientes normas de armonización:	Sono state recepite le seguenti norme di standardizzazione:	The following harmonised / designated standards were applied:	
EN ISO 12100:2010 EN IEC 61000-6-2:2019, EN IEC 61000-6-4:2019					

Euerdorf, 27 March 2023

Dr. Bassin Aryobsei, CEO

Dr. Matthias Lenhart, Technical Director



Drilling template



perma Distributor PRO MP-6



- 45 -



Drilling template

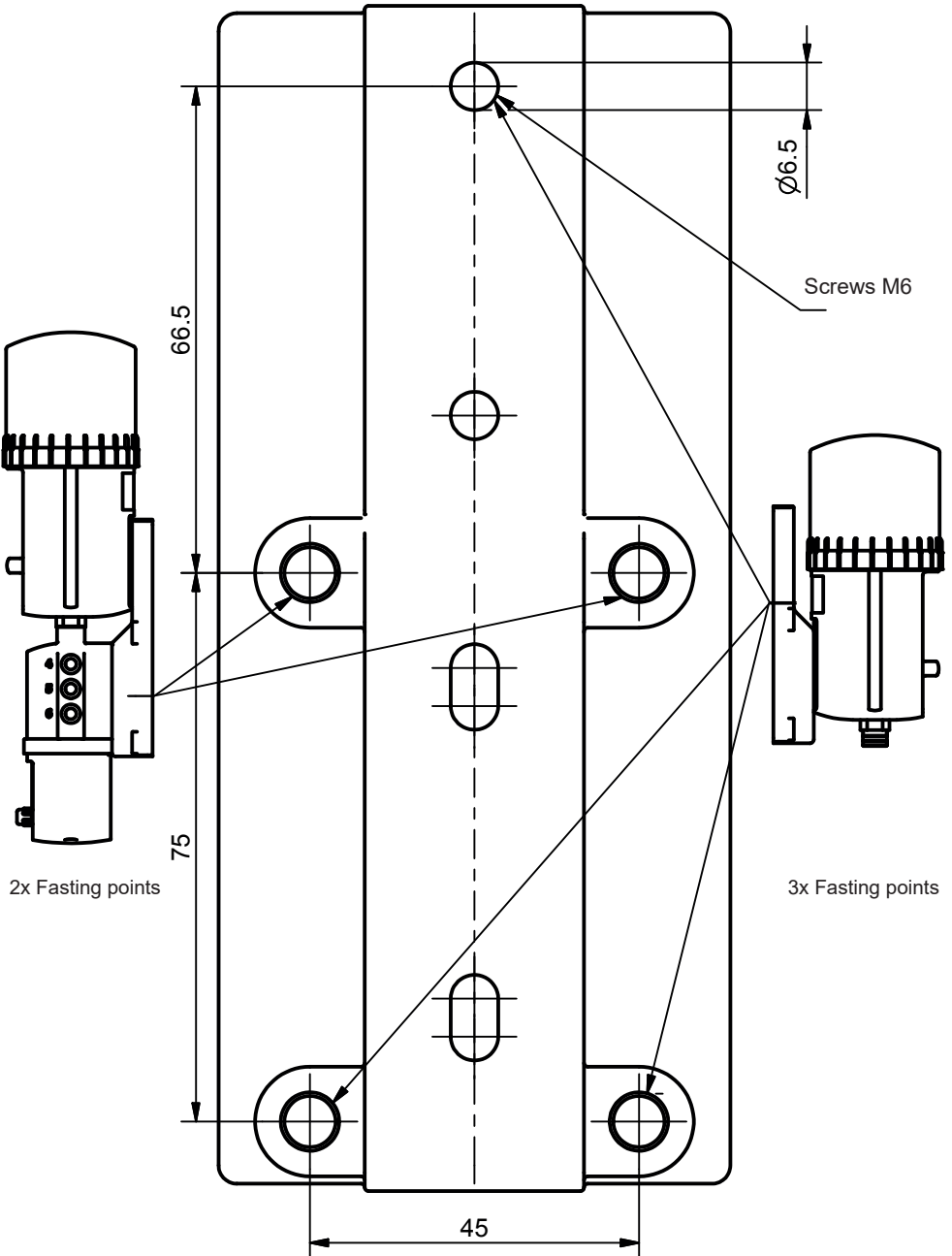

perma-tec GmbH & Co. KG
Hammelburger Str. 21
97717 Euerdorf
GERMANY

Tel.: +49 9704 609 - 0
info@perma-tec.com
www.perma-tec.com